

Widok z góry

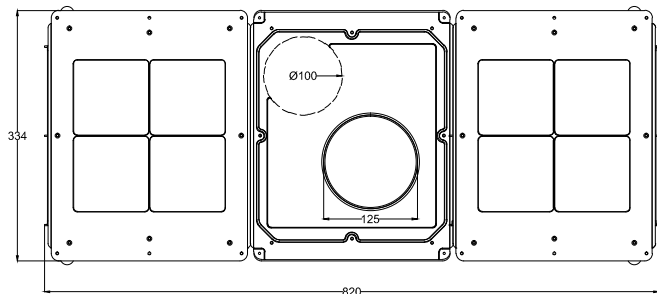

Widok od strony lewej

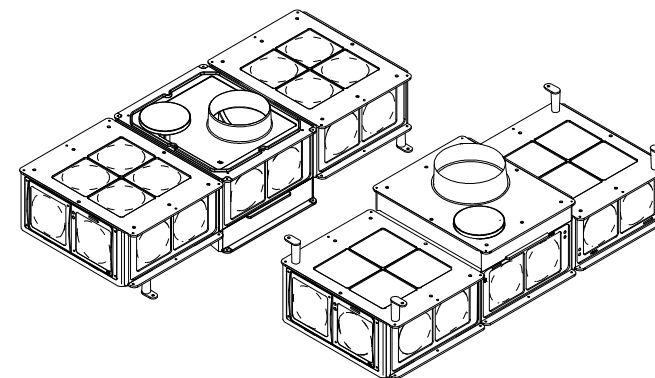
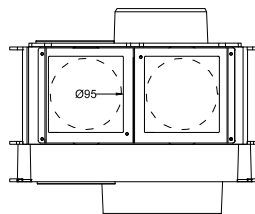

Widok z przodu

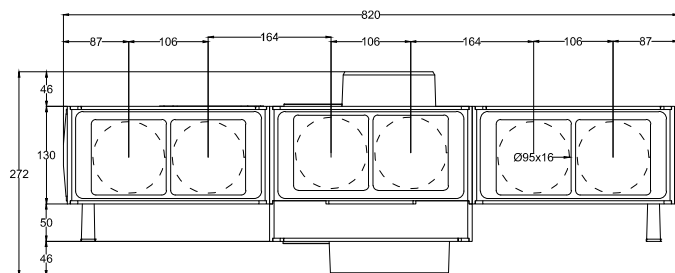

Widok od strony prawej

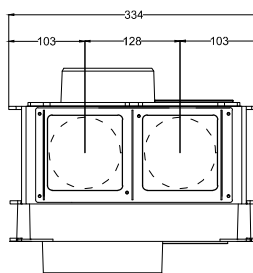

Widok z tyłu

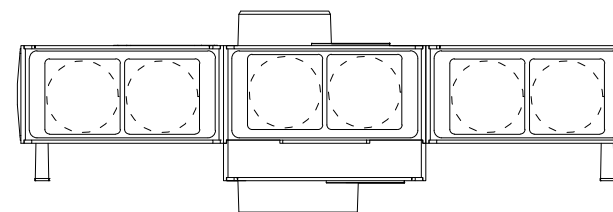

Widok z dołu

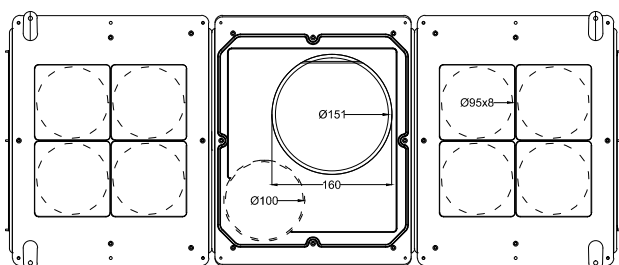

| | | | |
|---|---|---|-----------------------------|
|  | Kolektor F16/125G/160D SPIDERvent z ramą dystansową (filigran), wyjściem górnym 125mm i dolnym 160mm <small>Nazwa produktu</small> | | |
| | 26.11.2013 <small>Data</small> | ST KOLF-3G <small>Kod produktu</small> | 1:1 <small>Skala</small> |
| ST15 <small>Nr części</small> | FLOP SYSTEM Sp. z o. o., ul. Kiełczowska 64, 51-315 Wrocław biuro@flopsystem.pl tel. +48 71 325 14 20, NIP 8951767219 www.flopsystem.pl | | |