

Widok z góry

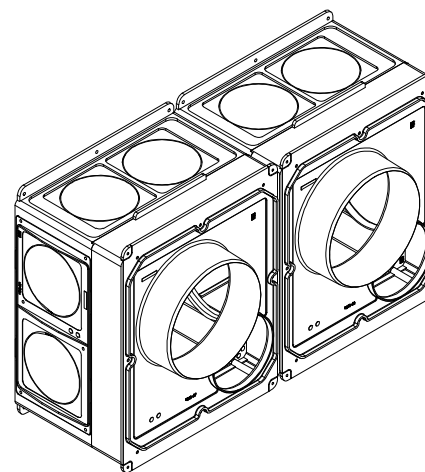

Widok od strony lewej

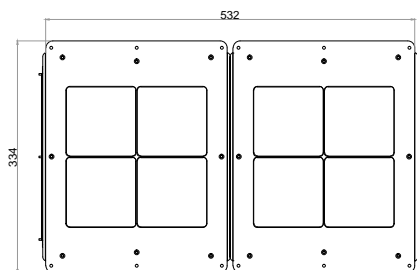
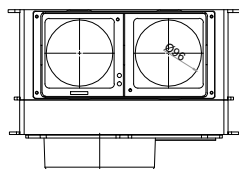

Widok z przodu

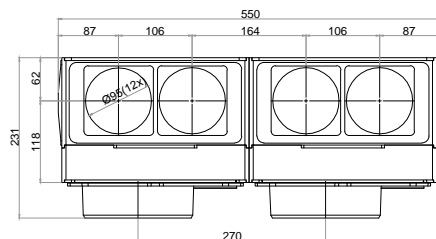

Widok od strony prawej

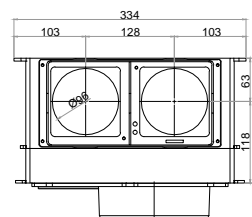

Widok z tyłu

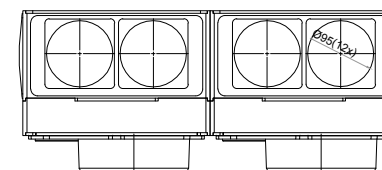

Widok z dołu

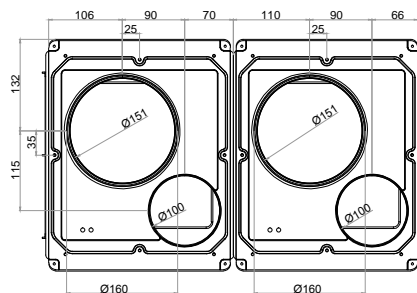

	Kolektor F12/2x160D SPIDERvent z ramą dystansową (filigran) z oddzielnymi wyjściami dolnymi 2x160mm		
	Nazwa produktu		
01.07.2014	ST KOLF-2D2	1:1	1
Data	Kod produktu	Skala	Revision
Nr części	FLOP SYSTEM Sp. z o. o., ul. Kielczowska 64, 51-315 Wrocław biuro@flopsystem.pl tel. +48 71 325 14 20, NIP 8951767219 www.flopsystem.pl		