

EASY CLICK alu

easy click
alu



Die Systemvariante easy click alu basiert auf einer stabilen, hochwertigen U-Profil-Schiene aus Aluminium. Leichtlaufende Clip-Gleiter aus alufärbigem Kunststoff werden eingeschoben und bieten den Kleiderbügeln mit dem patentierten easy click System sicheren Halt. Neben Standardlängen werden die Schienen in jedem gewünschten Sondermaß geliefert. Die maximale Anzahl der Kleiderbügel auf 1 Meter Aluschiene beträgt 25 Stück. Für die Montage gibt es verschiedene Möglichkeiten, die auf der folgenden Seite vorgestellt werden.

The system variation "easy click alu" is based on a stable, high-quality aluminium u-profile rail. Easy running clip sliders made of aluminium grey coloured plastic are slid in and hold the coat hangers safely in position with the patented easy click system. Apart from the standard lengths, the rails can be supplied in any desired special dimension. Maximum number of hangers on 1 meter of aluminium rail is 25 pieces. Please see the next page for an illustration of different mounting options.

Ausklippen des easy click Kleiderbügels

Click-out of the easy click coat hanger



1 Bügel nach oben drücken
Push the hanger up



2 Bügel nach unten ziehen
Pull the hanger down

Einklicken des easy click Kleiderbügels

Click-in of the easy click coat hanger



1 Bügel leicht einklicken (Ring sichtbar)
Gently click the hanger in (ring visible)



2 Bügel hält.
The hanger stays in position.



Der Designer Günther Sikora entwickelte mit easy click eine moderne Alternative zu herkömmlichen Kleiderbügeln und Garderoben. Ausgangspunkt für den innovativen Entwurf war die Idee einer organisierten, formal reduzierten Schrankausstattung. Das patentierte System funktioniert nach einem einfachen mechanischen Prinzip. Es zeichnet sich aus durch sicheren Halt, lautlosem Gleiten und grenzenloser Montagevielfalt. Außerdem ist es platzsparend, 360 Grad-wendig und pflegeleicht.

With easy click, the designer Günther Sikora has developed a modern alternative to conventional coat hangers and cloakrooms. His starting point for the innovative design was the idea of an organised and compact wardrobe. The patented system works following a simple mechanical principle. It distinguishes itself through its secure fixing, silent sliding mechanism and an unlimited variety of mounting options. Furthermore, it saves space, can be rotated through 360° and is easy to clean.

EASY CLICK alu



1 freihängende Montage auf Seitenclips
freely suspended mounting on side clips

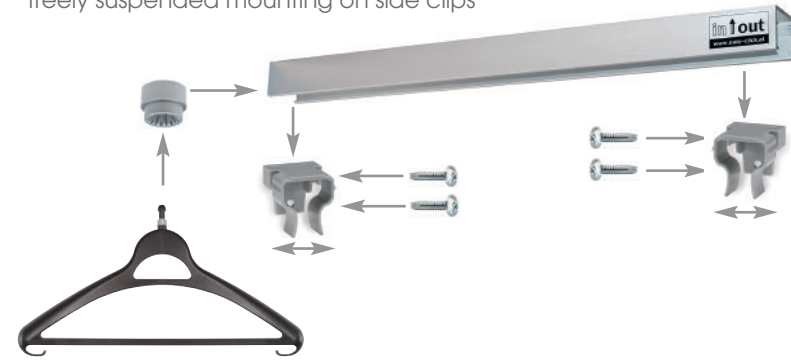

2 Montage direkt am Brett (quer angeschraubt)
Assemble direct on to the board (lateral screw connection)

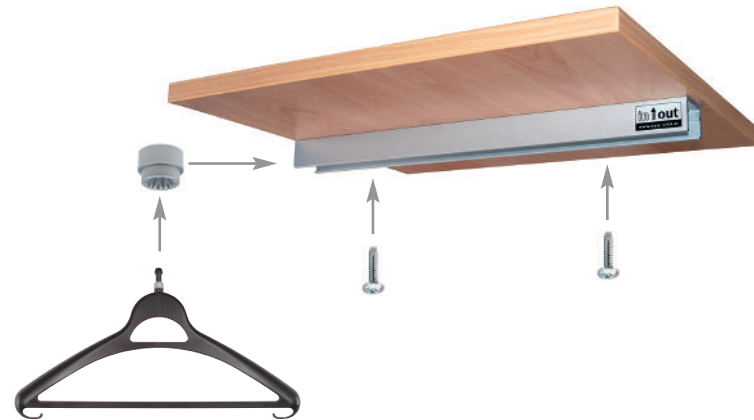

2a Montage direkt am Brett (nach vorne angeschraubt) mit passender Abdeckkappe und Stopper
Assemble direct onto the board (screw towards the front) with a suitable cap and stoppers

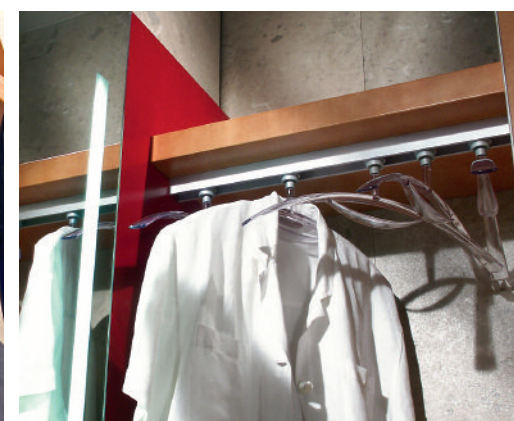

EASY CLICK alu

0912

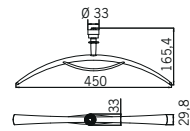

Bestellnummer/order no.
 0912/K1PK77
 0912/K10PK77
 0912/K77PK77
 0912/KG1K77
 0912/KG11K77
 0912/KG14K77
 0912/KGSA1K77
 0912/KGSA3K77
 0912/KGSA5K77
 VE / MOQ : 5

K1PK77

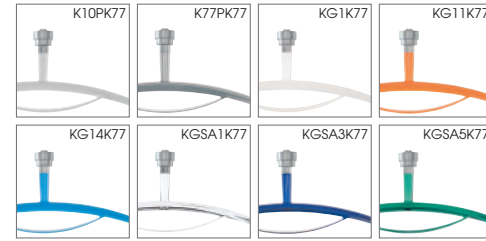

0905

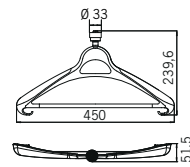

Bestellnummer/order no.
 0905/K1PK77
 0905/K10PK77
 0905/K77PK77
 0905/KG1K77
 0905/KG11K77
 0905/KG14K77
 0905/KGSA1K77
 0905/KGSA3K77
 0905/KGSA5K77
 VE / MOQ : 5

KG11K77

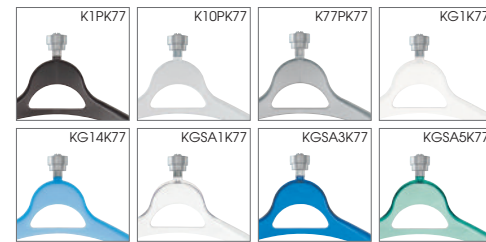

1782

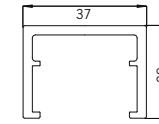

Bestellnummer/order no.
 1782-1000AL1
 1782-1500AL1
 1782-2000AL1
 1782-3000AL1
 VE / MOQ : 1
 bei Länge 3000 mm - Lieferung unfrei /
 by length 3000 mm - delivery unfree

AL1



U-EC002

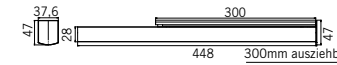

Bestellnummer/order no.
 U-EC002-450A
 VE / MOQ : 1

A

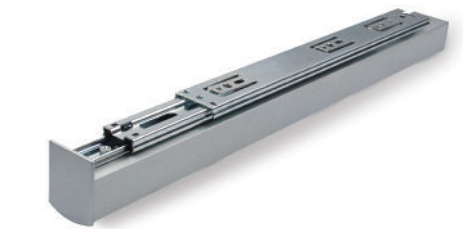

0996

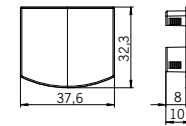

Bestellnummer/order no.
 0996/MV11K77P
 VE / MOQ : 10

MV11K77P

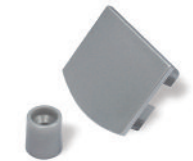

0983

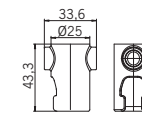

Bestellnummer/order no.
 0983-34K77
 0983-34KGSA1
 VE / MOQ : 10

K77



0961

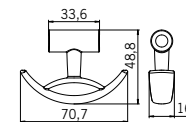

Bestellnummer/order no.
 0961-70K77P
 0961-70KGSA1
 VE / MOQ : 10

K77P



0905

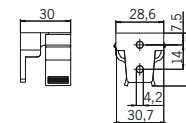

Bestellnummer/order no.
 0905-30K77V2*
 VE / MOQ : 10
 *Bestellnr. für 2 Stück / order no. for 2 pcs.
 VE / MEQ 5 = 10 Stück / pieces

K77



Bestellnummer/order no.
 0905-30K77
 Industrieverpackt / bulk packed