



PRODUCT CATALOG - EDITION 01/2023



SMALL ARCHITECTURE

SMALL ARCHITECTURE

88



FACADES

FACADES	82
WINDOW SILLS	86
CORNICES	86
WALL CLADDINGS	87



 **DASAG**



LAGO

Immediately after forming, the surface of the elements is "rinsed" using multiple high-pressure water jets.

As a result, aggregate grains are partly uncovered, showing its shape and color, and the surface of the elements is roughened and acquires high anti-slip parameters.

SURFACE FINISHING TECHNOLOGIES

BELLO

The surface of the elements is treated using multi-head grinders equipped with diamond and carborundum tools. Depending on the granulation of the tools, we obtain a surface with various degrees of anti-slip, which have a common feature: a slight sheen that enhances the beauty of the natural stone aggregates used in the production process.

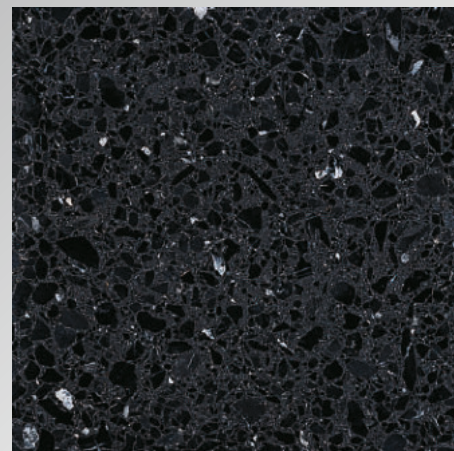

PRATO

The surface of the elements is blast-treated using steel balls, commonly known as "sandblasting".

As a result, grains of natural stone aggregates are partially exposed, the surface becomes roughened and acquires a unique character.

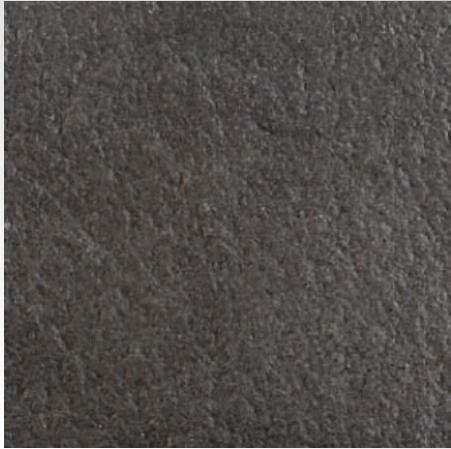

LAVE

The surface of the elements faithfully reproduces shapes and colors given to it in the process of forming. In addition there is additional homogenization and carbonation in the process of thermal hardening.



RESISTANT SLIP

roughened surface, tiles are characterized by anti-slip class from R10 to R13



EASY TO KEEP CLEAN

ground surface makes it easy to keep clean, external impregnation is recommended



DIRT RESISTANCE

the product is subjected to a hydrophobization process and external impregnation



RESISTANT TO WEATHER CONDITIONS

the product is characterized by high frost resistance



REDUCED THICKNESS AND WEIGHT

thanks to innovative technology, the thickness of the tile is reduced to 2 cm single-layer board (plate/tile) (does not have a primer layer)



REDUCED THICKNESS AND WEIGHT

8 cm thick tiles, are characterized by high endurance during use, heavy vehicular traffic is allowed



ANTI-ELECTROSTATIC TILE

the technology meets the requirements for protection against static electricity according to the standards described in certificates available at: www.dasag.pl





EXTERNAL
PAVEMENTS

PUBLIC SPACE

Public space is an area of particular importance to the inhabitants of the city. Appropriate development - guaranteeing comfort, relaxation, enabling involvement in what is happening around, allows for meeting the social needs of its users.

Thanks to our products, the public space of cities becomes more friendly, functional and beautiful improving the quality of life of their inhabitants.





HOME AND GARDEN



The space around the house requires not only an aesthetic and beautiful arrangement, but also the highest quality materials. PROBET-DASAG solutions are an opportunity to create unique projects emphasizing the beauty of your place of residence. A variety of designs and depth of colors our products owe to nature. Their rich colors and unusual texture allows for unlimited possibilities of effective combinations, perfectly fit into the natural surroundings of each property. Get inspired by the wide range of different formats, colors and patterns possible to create surfaces. Make your dream project a reality!

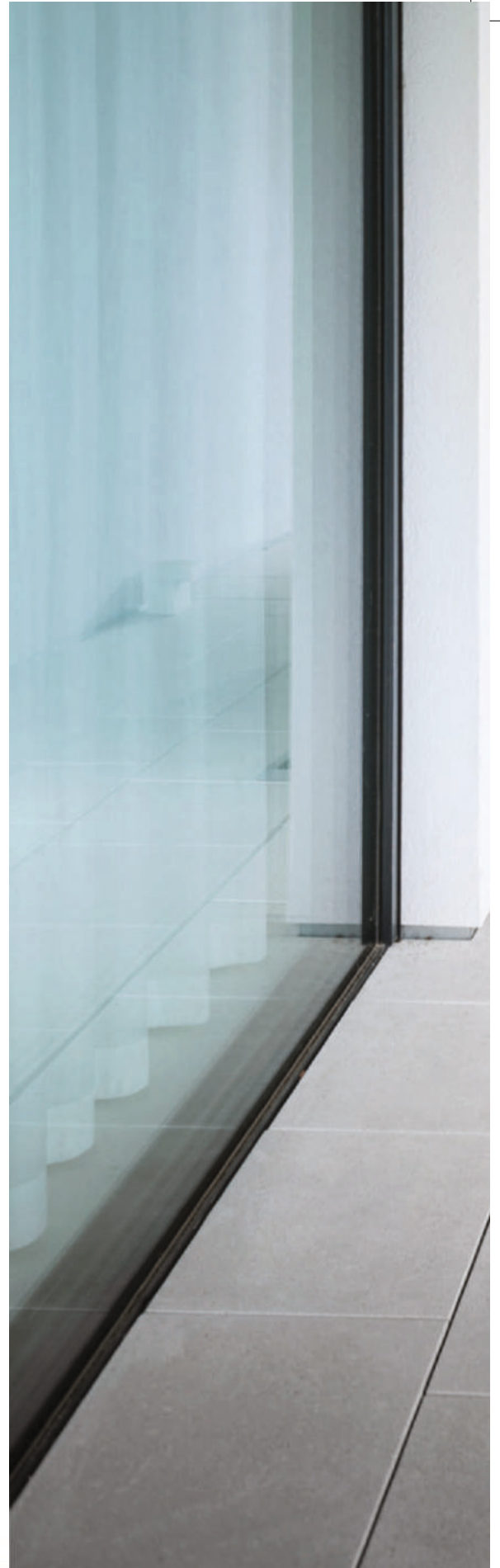



ARIA PRATO



Eco tile

Created on the basis of innovative pro-environmental technology, Aria tile enable the reduction of pollution and support the active fight against smog that is dangerous to health. All this is due to the top layer, because the Aria ecological tile has in its composition nanocrystalline titanium dioxide TiO₂.

What is its secret? Eco-friendly materials building blocks from the Aria series, subjected to the photocatalysis process, they remove nitrogen oxides, NO_x, which are extremely dangerous for the human body, which are present in polluted air, and are up to ten times more harmful than carbon monoxide. To initiate the cleaning process, only the UV radiation present in the sunlight is necessary, so Aria tiles are constantly "working" in our favor. Nanocrystalline titanium dioxide does not leach out during the operating period, so it remains present in an unchanged form during the entire life cycle of the concrete element. Moreover, the outer tiles from Dasag containing TiO₂ has the ability to self-clean from various types organic dirt.



AVAILABLE FORMATS:



35 x 35 x 5 or 8 cm



40 x 40 x 4 or 8 cm



50 x 50 x 4,3 or 8 cm



60 x 40 x 4 or 8 cm



60 x 60 x 4 or 8 cm



80 x 40 x 4,3 cm

PROMENADA PRATO

Aesthetics and functionality

Distinctive structure with visible noble grain seam and slightly roughened surface make that the PROMENADA series is an extremely decorative element of the landscape of urban space. The collection consists of tile with a thickness of 8 cm, intended for the construction of pedestrian and road transport routes. Thanks to the diversity of the form and size of the tiles, it is possible to create tailored and original compositions.

PROMENADA tiles are characterized by particularly high resistance to mechanical damage and abrasion, so they can be used in places where passenger car traffic is allowed and, occasionally, truck traffic. Products from the PROMENADA series are also characterized by: high anti-slip properties, low water absorption and high frost resistance.



PROMENADA 7431



PROMENADA 7437

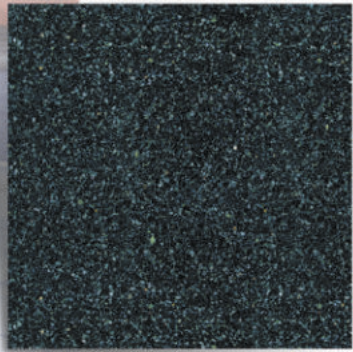

PROMENADA 7438



PROMENADA 5220



PROMENADA 7449



PROMENADA 7232



AVAILABLE FORMATS:



40 x 40 x 8 cm



50 x 50 x 8 cm



60 x 29,8 x 8 cm



60 x 40 x 8 cm

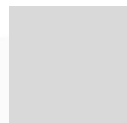

60 x 60 x 8 cm



39,9 cm



80 x 20 x 8 cm

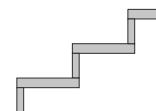

COMPLEMENTARY PRODUCTS ARE AVAILABLE

FAVILLA PRATO

Beautiful and modern design

The large-format FAVILLA tiles is the quintessence of dreams about space and freedom. Subtle colors will allow you to arrange your surroundings in a distinct way, characterized by simplicity and purity of form. The unique character of the Favilla tiles is emphasized by light-reflecting particles. Thanks to them, your surroundings will take on an exclusive and elegant form, and high performance parameters will ensure peace and security for you and your family.

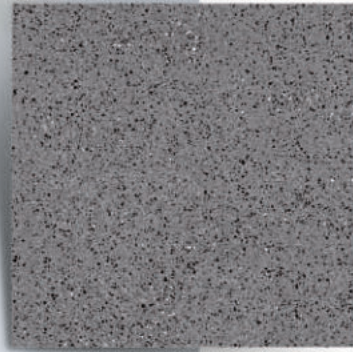

FAVILLA 7232

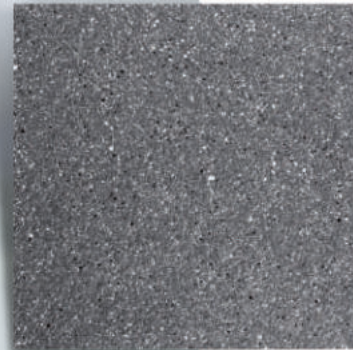

FAVILLA 7253



FAVILLA 7380



FAVILLA 7381



AVAILABLE FORMATS:



40 x 40 x 4 cm



50 x 50 x 4,3 cm



60 x 40 x 4 cm



60 x 60 x 4 cm



80 x 40 x 4,3 cm

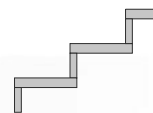

COMPLEMENTARY PRODUCTS
ARE AVAILABLE

LUMINA PRATO



Jewelry for the city

Lumina Prato tiles are an extremely effective combination of functional and utilitarian values with a decorative material structure. Such a set of features makes them an ideal material that will easily respond to needs of even the most demanding investors and their projects. We have 4 fashionable natural colors to choose - timeless gray in two different shades, elegant graphite and an intriguing variation about greenery. But it is not everything! Design dimension of Lumina Prato decorative panels complements the labradorization effect. This means that the shimmering and light-reflecting mineral was used in the structure of the material. Thanks to this, terrace tiles gain a specific glow, becoming an original piece of jewelry for any space.



LUMINA PRATO 7422



LUMINA PRATO 7423



LUMINA PRATO 7424



LUMINA PRATO 7425



AVAILABLE FORMATS:



40 x 40 x 4 cm



50 x 50 x 4,3 cm



60 x 40 x 4 cm

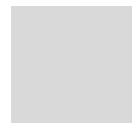

60 x 60 x 4 cm



80 x 40 x 4,3 cm

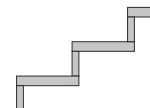

COMPLEMENTARY PRODUCTS ARE AVAILABLE

ATENY PRATO

Power drawn from granite

Tiles from the ATENY series are an excellent combination of values utilitarian and extremely decorative structure. The PRATO finish brings out and emphasizes the beauty of the natural material. A diverse range of colors faithfully reflects the colors of nature, thanks to which the tiles from this collection perfectly blend in with the landscape of parks or gardens. Made of selected granite aggregates ATENA tiles are strong and durable, they are characterized by also highly resistant to environmental factors atmospheric.



ATENY 7330



ATENY 7568



ATENY 7819



ATENY 7820



ATENY 7821



AVAILABLE FORMATS:



40 x 40 x 4 cm



50 x 50 x 4,3 cm



60 x 40 x 4 cm

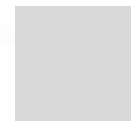

60 x 60 x 4 cm



80 x 40 x 4,3 cm

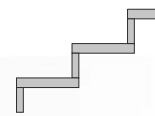

COMPLEMENTARY PRODUCTS
ARE AVAILABLE

NEW!



INDIGO PRATO 7374



INDIGO PRATO 7430*



ELBA**



INDIGO PRATO 7431*



INDIGO PRATO 7437

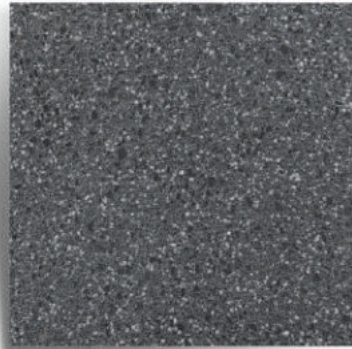

INDIGO PRATO 7438



INDIGO PRATO 7857

INDIGO PRATO



Beauty with character

Unique structure and expressive color mix. INDIGO tileseries made in the PRATO technology gain an interesting character. As a result of the "sandblasting" grains of natural stone aggregates remain partially exposed - the surface becomes slightly rough. INDIGO tiles made of selected aggregates PRATO are characterized by high durability and resistance to weather conditions. Varied form and the size of the tiles allows you to create matching and original compositions.



AVAILABLE FORMATS:



40 x 40 x 4 cm



50 x 50 x 4,3 cm



60 x 40 x 4 cm

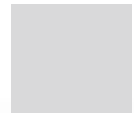

60 x 60 x 4 cm



80 x 40 x 4,3 cm

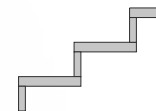

COMPLEMENTARY PRODUCTS ARE AVAILABLE



* The Solar Reflectance Index (SRI) for: 7430 tile - 86,0 and 7431 - 73,1 (ASTM E 1980-11 norm)



The highest anti-slip class (class C), confirmed by testing on a wet surface without shoes (DIN 51097)

** Elba tile has no complementary elements



INDIGO BELLO 7105



INDIGO BELLO 7234



INDIGO BELLO 7430



INDIGO BELLO 7431



INDIGO BELLO 7432



INDIGO BELLO 7828

INDIGO BELLO

Always clean

Delicate to the touch, smooth surface and natural palette of colours. The surface of the tiles, grounded in the machining process, gains a delicate gloss that enhances the beauty of natural stone aggregates that were used in the production process. The INDIGO collection is characterized by high durability, abrasion resistance and resistance to weather conditions, including high frost resistance. Due to the significant smoothing of the surface, they are easy to keep clean. Perfect for balconies and terraces.



AVAILABLE FORMATS:



40 x 40 x 4 cm



50 x 50 x 4,3 cm



60 x 40 x 4 cm



60 x 60 x 4 cm



80 x 40 x 4,3 cm

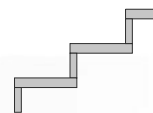

COMPLEMENTARY PRODUCTS ARE AVAILABLE



MADERA PRATO 5220



MADERA PRATO 5223



MADERA PRATO 5224

MADERA PRATO

Holiday landscape

Madera Prato tiles are characterized by natural colors and an interesting texture. The collection enables the implementation of projects in both Mediterranean and modern, minimalist styles. The main distinguishing feature of the series is monochrome, whose universal character allows for wide range of application. plates successfully they can be the surface of a home terrace or garden path. Non-slip surface obtained by a process called "sandblasting" provides a high level of security. This method also allows you to emphasize the natural beauty of the aggregate. Madeira Prato is synonymous with comfort and high functionalit. Availability of tiles in shades of subdued beige, expressive graphite, subdued white and gray will make it possible creatingan aestheetiarrangement.



AVAILABLE FORMATS:



40 x 40 x 4 cm



50 x 50 x 4,3 cm



60 x 40 x 4 cm



60 x 60 x 4 cm



80 x 40 x 4,3 cm

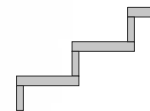

COMPLEMENTARY PRODUCTS ARE AVAILABLE

BERLINER TILE PRATO

Inspired by tradition

Slightly roughened texture, eye-catching structure and the pre-war 35x35 cm format - modernity is associated with tradition here. The tile are offered in several color versions, which are an ideal basis for designing original compositions. Perfect for recreating a historic character. The Berlin tile is perfect for large ones surfaces intended for pedestrian traffic and car traffic.



PLYTKA BERLIŃSKA 7275



PLYTKA BERLIŃSKA 7283



PLYTKA BERLIŃSKA 7292*



PLYTKA BERLIŃSKA 7313

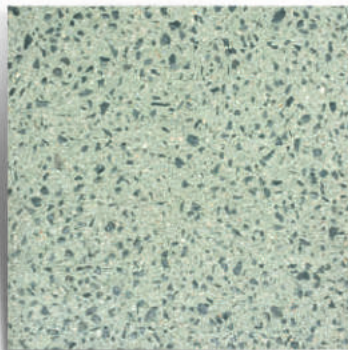

PLYTKA BERLIŃSKA 7317



PLYTKA BERLIŃSKA 7348*



AVAILABLE FORMATS:

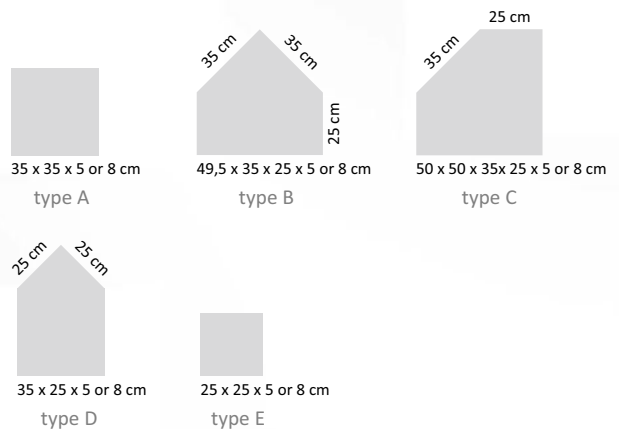

* milled tile



BAVARIA 7430



BAVARIA 7431

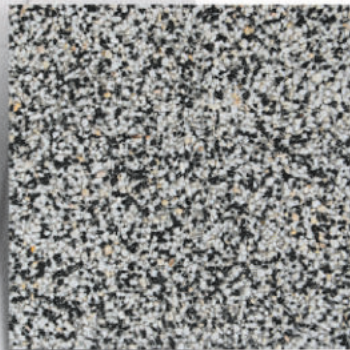

BAVARIA 7437

BAVARIA

LAGO

Rough handling – safe in walking

The BAVARIA series impresses with its expressive structure and unique color melange. Thanks to the use of a special refinement technology, the surface of the tiles obtains an effective, roughened texture. BAVARIA tiles are characterized by high durability and resistance to weather conditions, including frost resistance and low water absorption. Thanks to the extremely high anti-slip properties, the surface of the tile will be safe for users even after heavy rainfall. BAVARIA collection is especially recommended for surfaces by swimming pools, bathing areas, entrances to buildings and driveways for people with disabilities.



AVAILABLE FORMATS:



40 x 40 x 4,3 cm

GRANDE

PRATO

Large format specialist

The large-format GRANDE series boards are the perfect material for arranging pedestrian routes, their thickness can be up to 20 cm. The GRANDE series boards allow you to create freely space both in terms of size and format and applied design. Their additional advantage is high abrasion resistance and resistance to mechanical damage and weather conditions.

Possibility of execution in architectural concrete technology.



AVAILABLE FORMATS:

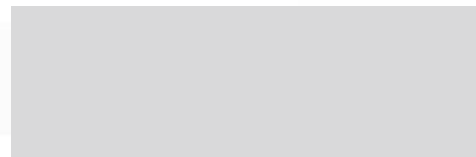

max 300 x max 120 x 8-20 cm

TOSCANA LAVE

Southern warmth

The warm color of the TOSCANA series tiles breaks the dominance of cool shades. Subdued colors and original structure of broken sandstone - the collection complements the landscape with its unique beauty, harmonizing both with classic elegance and modern minimalism.

TOSCANA series tiles are durable and resistant to abrasion and weather changes. They will prove themselves excellent in places loaded with intense use.

TOSCANA 6220

TOSCANA 6221

NEW!

TOSCANA 6233

NEW!

TOSCANA 6234



AVAILABLE FORMATS:



40 x 40 x 4,3 cm



TAKTILE PAVEMENTS

Tactile marking systems make it easier for the blind and visually impaired people to move around on their own in public space, providing basic information about dangerous or important places. Touch systems support moving around objects related to the communication infrastructure, public utility facilities or shopping malls. They increase the safety of people with disabilities and contribute to their social activation. Through tactile stimulation they increase freedom of movement and independence in making communication decisions for people with disabilities.

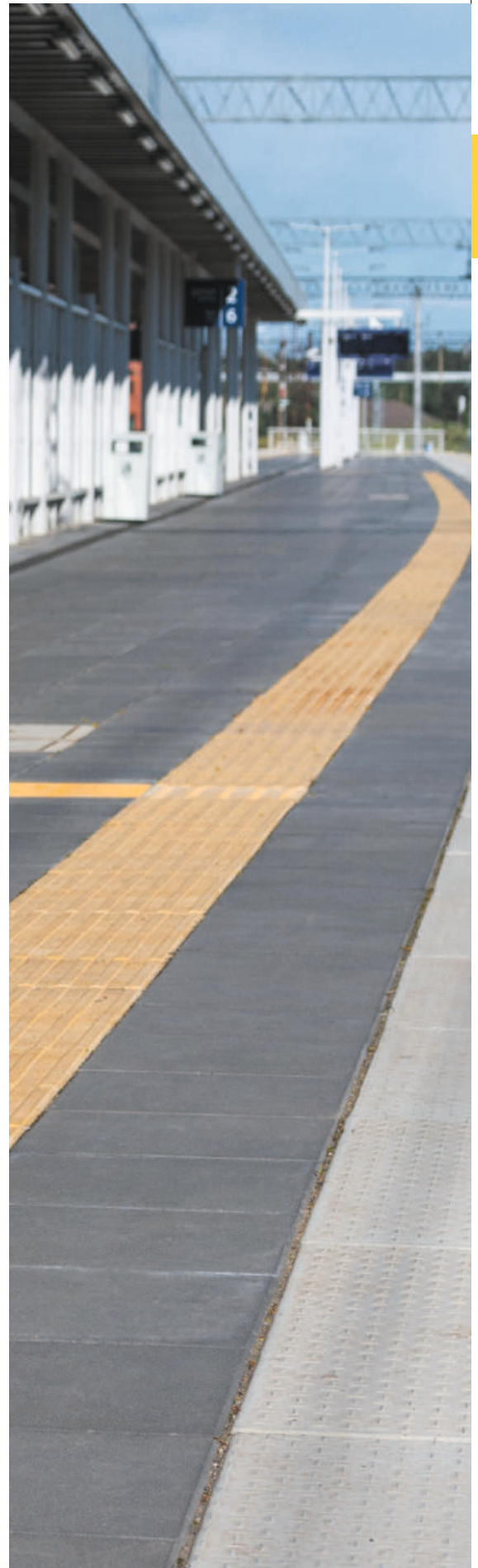

COMPLEMENTARY PRODUCTS EXTERNAL PAVEMENTS

Complementary products for:

PROMENADA PRATO
FAVILLA PRATO
LUMINA PRATO
ATENY PRATO
INDIGO PRATO
INDIGO BELLO
MADERA PRATO

AVAILABLE FORMATS:	Thickness [cm]	
Wall/stair plinth h=7.1 cm	mb/kpl	1,3
Corner element, max 40 cm wide and 220 cm lenght	mb	4,0
Corner element, max 40 cm wide and 220 cm lenght	mb	5,0
Step + riser max 120 cm lenght	mb	4,0
Block steps	mb	do 20
Flat element, 20-50cm wide and max 160 cm lenght	mb	4,0
Flat element, 25-50cm wide and max 190 cm lenght	mb	5,0
Facades and others	indywdual price	

Complementary products for:

TAKTILE PAVENETS

Aplicaton	Type	Dimensions [cm]	Thickness [cm]
Railway facilites	Warning elements	40x40	4,0 or 8,0
	Guiding elements	40x40	4,0 or 8,0
	Road junction elements	60x60	8,0
Metro facilites	Warning elements	40x40	4,0
	Guiding elements	40x40	4,0
	Guiding elements	60x40	4,0
External elements DIN 32984	Warning elements	30x30	4,0
	Guiding elements	30x30	8,0
Internal elements DIN 32984	Warning elements	29,8x29,8	2,0
	Guiding elements	29,8x29,8	2,0



FLOOR TILES

FLOOR TILES

Public places play a special role in our lives. It is important to give them a unique and unrepeatabe atmosphere. A variety of patterns, beautiful colors and perfect performance parameters make our tileswork well in both construction and residenntiaprojects, giving them a unique character.



TERRASTONE

BELLO

Large format solutions

The TERRASTONE collection consists of unique, single-layer large-format tiles with excellent performance parameters. Durable and resistant to abrasion, they are a beautiful and practical material. Thanks to its advantages they are perfect as aesthetic and functional interior finishing. Terrastone tiles are created thanks to innovative technology that enables the production of large formats in a thickness reduced to 21 mm. Perfect for a variety of types of applications, ideal for platforms and landings with sound insulation determining the thickness of the material. They are also perfect for other surfaces that require the use of large-format tiles with reduced thickness and weight.



AVAILABLE FORMATS:



60 x 29,8 x 2,1 or 2,5 or 2,7 cm



60 x 60 x 2,1 or 2,5 or 2,7 cm

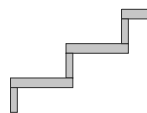

COMPLEMENTARY PRODUCTS
ARE AVAILABLE



TERRASTONE 7430

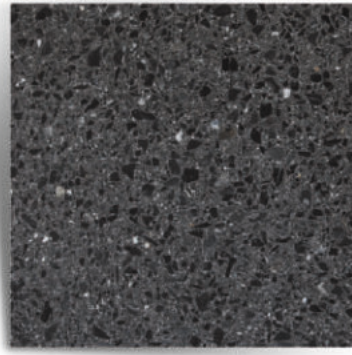

TERRASTONE 7514



TERRASTONE 7105



TERRASTONE 7032



TERRASTONE 7568



TERRASTONE 7431



TERRASTONE 7234



TERRASTONE 7387



TERRASTONE 7388



SELECT BELLO

Versatility and durability

Produced from local aggregates, the SELECT series combines functional and aesthetic values. Variety of colors and forms used in the production of natural stone allows you to get an interesting effect both under in terms of the structure and color of the tiles. A wide range of formats and color versions of SELECT tiles means unlimited possibilities of combining them and creating compositions. The SELECT collection will give the space a stylish look, being the decoration of any interior. Thanks to the excellent technical parameters, these tiles are also perfect for places with particularly intensive use.



AVAILABLE FORMATS:



30 x 30 x 3 cm



40 x 40 x 4 cm



50 x 50 x 4,3 cm



60 x 29,8 x 4 cm



60 x 40 x 4 cm



60 x 60 x 4 cm



80 x 40 x 4,3 cm

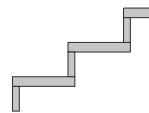

COMPLEMENTARY PRODUCTS
ARE AVAILABLE



SELECT 7234

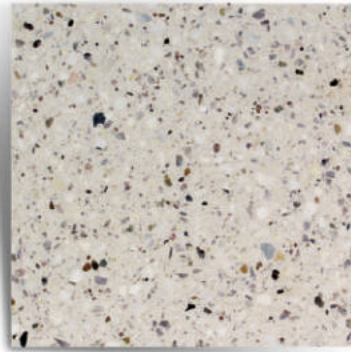

SELECT 7416



SELECT 7417



SELECT 7430



SELECT 7431



SELECT 7432



SELECT 7437

BASICS

BELLO

Creative opportunities

The beauty of a unique structure and a natural palette of colors combined in an original mélange. The BASICS collection offers unlimited creative possibilities. Wide range formats and color versions allows you to create original and stylish compositions. High resistance to mechanical damage and abrasion make these tiles ideal for high-traffic areas. The BASICS S tiles thanks to their properties, are ideal as aesthetic and functional finishing of shopping malls, traditional and large-format stores.



AVAILABLE FORMATS:



30 x 30 x 3 cm



40 x 40 x 4 cm



50 x 50 x 4,3 cm



60 x 29,8 x 4 cm



60 x 40 x 4 cm



60 x 60 x 4 cm



80 x 40 x 4,3 cm

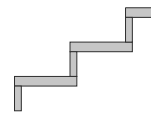

COMPLEMENTARY PRODUCTS
ARE AVAILABLE



BASICS 7032



BASICS 7060



BASICS 7070



BASICS 7490

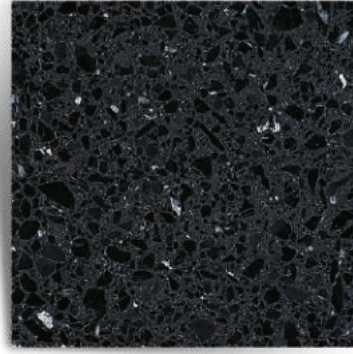

BASICS 7508

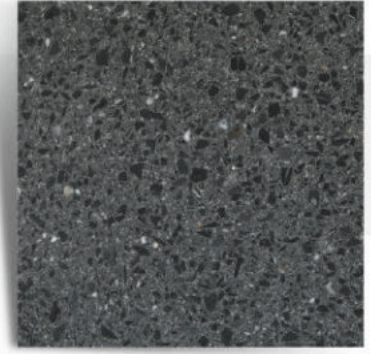

BASICS 7514



BASICS 7528



BASICS 7568



BASICS 7638

NORDIC BELLO

Chic and functional

Tiles from the NORDIC collection guarantee a stylish arrangement. The expressive structure and natural colors make it possible to create subdued, yet effective compositions, emphasizing the elegant, timeless character of the interiors. NORDIC tiles are characterized by high durability and abrasion resistance, making them suitable for places with intensive use.



AVAILABLE FORMATS:

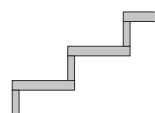
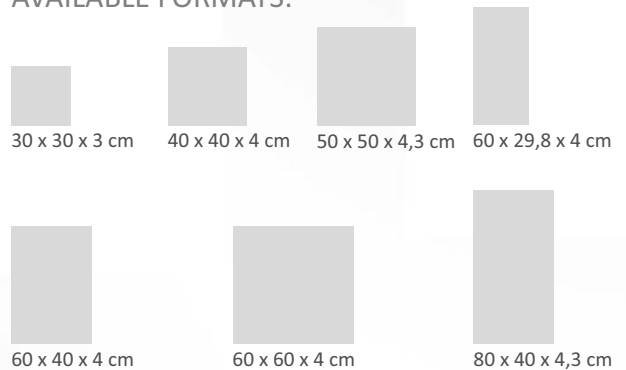

COMPLEMENTARY PRODUCTS ARE AVAILABLE

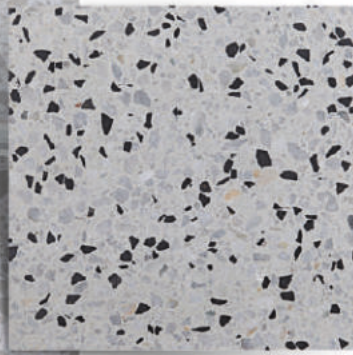

NORDIC 7094

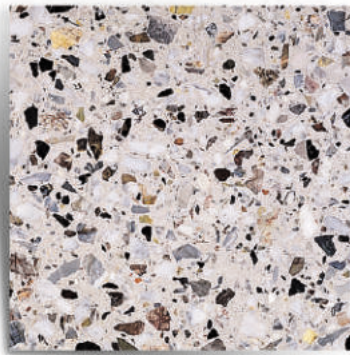

NORDIC 7124

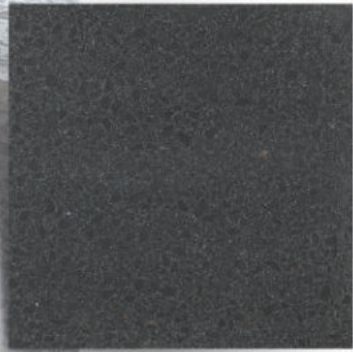

NORDIC 7233

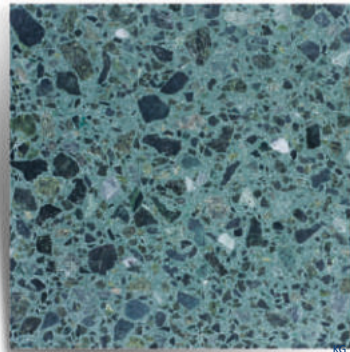

NORDIC 7479



NORDIC 7325



NORDIC 7826

FORZA BELLO



FORZA 7124



FORZA 7530



FORZA 7233



FORZA 7430

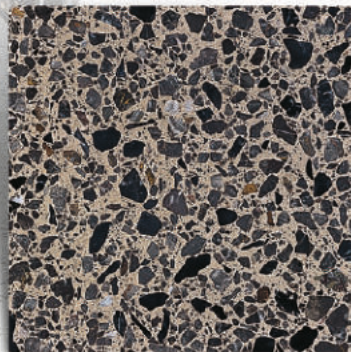

FORZA 7598*

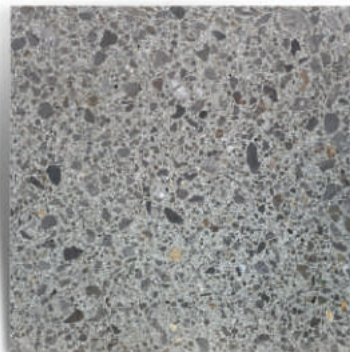

FORZA 7599*

PLATES FOR SPECIAL TASKS

FORZA series tiles are power and durability, that meet all requirements. The collection consists of tiles with a thickness of 3.0 cm, 3.5 cm and 4.0 cm. FORZA tiles are characterized by a particularly high resistance to mechanical damage, so they can be used not only for private purposes properties, but also in particular exposed places to static and dynamic loads. The FORZA collection, thanks to its unique colors, is ideally suited to public facilities – markets or market halls. FORZA is also a 7598 tile with antistatic properties, so it can be used in special facilities, such as stations gas or fuels.



AVAILABLE FORMATS:

Plates with increased load resistance



24,7 x 24,7 x 4 cm
(for 7233 and 7430)



30 x 30 x 3,5 cm
(for 7124 and 7530)

Antistatic plates*



30 x 30 x 3 cm
(for 7599)



30 x 30 x 3,5 cm
(for 7598)

* 7598 and 7599 tiles are antistatic and highly conductive materials. Read more: www.dasag.eu

COMPLEMENTARY PRODUCTS FLOOR TILES

Complementary products for:

SELECT BELLO
BASICS BELLO
NORDIC BELLO

AVAILABLE FORMATS:	Thickness [cm]	
Wall/stair plinth h=7,1 cm	mb/kpl	1,3
Corner element, max 40 cm wide and 160 cm lenght	mb	4,0
Corner element, max 40 cm wide and 220 cm lenght	mb	5,0
Step + riser max 120 cm lenght	mb	4,0
Flat element, 20-50cm wide and max 160 cm lenght	mb	4,0
Flat element, 25-50cm wide and max 190 cm lenght	mb	5,0

Complementary products for:

TERRASTONE BELLO

AVAILABLE FORMATS:	Thickness [cm]	
Plinth 60x7,1 cm	mb/kpl	1,3
Plinth 60x7,1 cm	mb/kpl	2,1
Plinth 60x7,1 cm	mb/kpl	2,5
Plinth 60x7,1 cm	mb/kp	2,7





STAIRS



INTERNAL STAIRS



Stairs in modern buildings are no longer just a way to lead to the upper floor. So it's not surprising that we've come to treat them as interior design element. Extremely wide range of colors and textures of terrazzo cladding encourages creativity. And thanks to the possibility of using contrast inserts and non-slip, the comfort of using the staircases increases.

EXTERNAL STAIRS

External stairs - elegant and stylish, can decorate the entire building. However, in the places exposed to intensive exploitation, aesthetic must be accompanied by utility values. Terrazzo combines natural beauty, durability and safety of use. Resistant to abrasion, weather conditions and mechanical damage, terrazzo works perfectly as a stair cladding or block of stairs to the outside of the building.



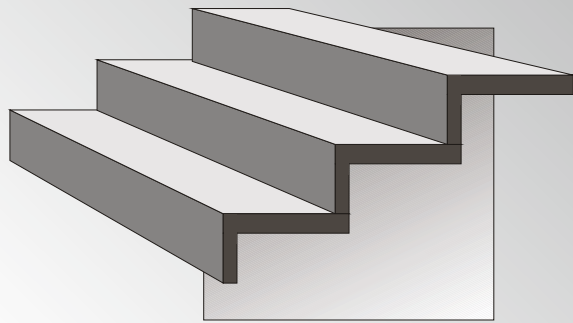

Straight angle steps

The combination of the top plate and the riser into one integrated whole is a solution thanks to which we can easily build new stairs and cover old ones. Their elegant and at the same time timeless form makes that they can be used in projects of various styles.

RODZAJE SCHODÓW

Undercut angle steps

The combination of the top plate and the riser into one integrated whole is a solution thanks to which we can easily build new stairs and cover old ones. Their elegant and at the same time timeless form makes that they will be used in projects of various styles. Similarly to block steps, they have very high strength parameters and can be used as load-bearing elements. Made in various refinement technologies BELLO and PRATO surface are very attractive material for the construction of stairs.

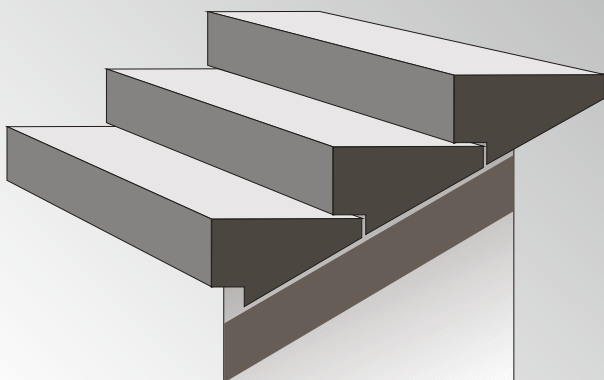
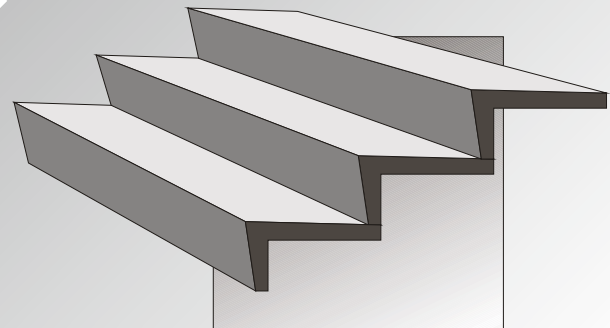

Wedge steps (Keilstufen)

The combination of the top tile and the riser into one whole is a solution thanks to which we can easily make new stairs and we can cover the old ones. Their elegant and at the same time timeless form makes that they will be used in projects of various styles. Similarly to block steps, they have very high strength parameters and can be used as load-bearing elements. Made in various surface refinement technologies BELLO and PRATO are very attractive material for the construction of stairs. Unlike block steps, wedge steps have a cut back wall, and matched to the preceding stair tread indentation on the front edge of the steps enable very quick assembly of the entire staircase.

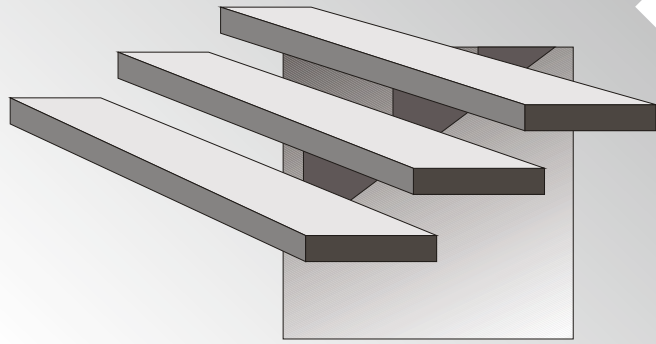

Self-supporting stairs supported on the beam

Modern form, despite the aesthetic lightness, is characterized by high resistance to static and dynamic loads. This stair system can also be mounted on lightweight structures, and the ability to produce its elements in any shape and sizes allows for easy adjustment of the arrangement of steps to individual requirements.

Block stair treads

Solid, massive stairs refer to the style of a dignified, classic design. Variety of finishes surface - BELLO and PRATO - makes these stairs can be a unique decoration for the entire building, despite their simplicity. Stair blocks can be stacked directly on properly profiled, hardened ground, which reduces costs execution.

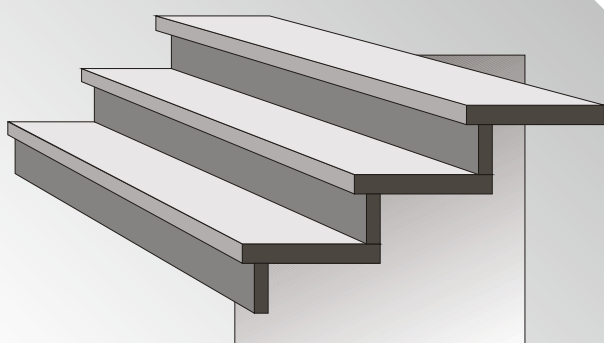
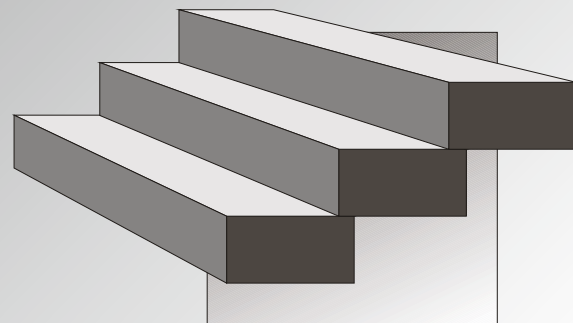

Steps and riser

Modern form, despite the aesthetic lightness, is characterized by high resistance to static and dynamic loads. This stair system can also be mounted on lightweight structures, and the ability to produce its elements in any shape and sizes allows for easy adjustment of the arrangement of steps to individual requirements. Two-element steps consisting of a stair tread and risers. Thanks to extending the stair above the edge of the step, an additional usable area is obtained.

INSERT PLINTHS

In our offer you will find all the necessary products for comprehensive implementation stairs, terraces, balconies. A wide range of wall plinths, stairs plinths, curbs and edges guarantee full color consistency with cladding and tilecollections.

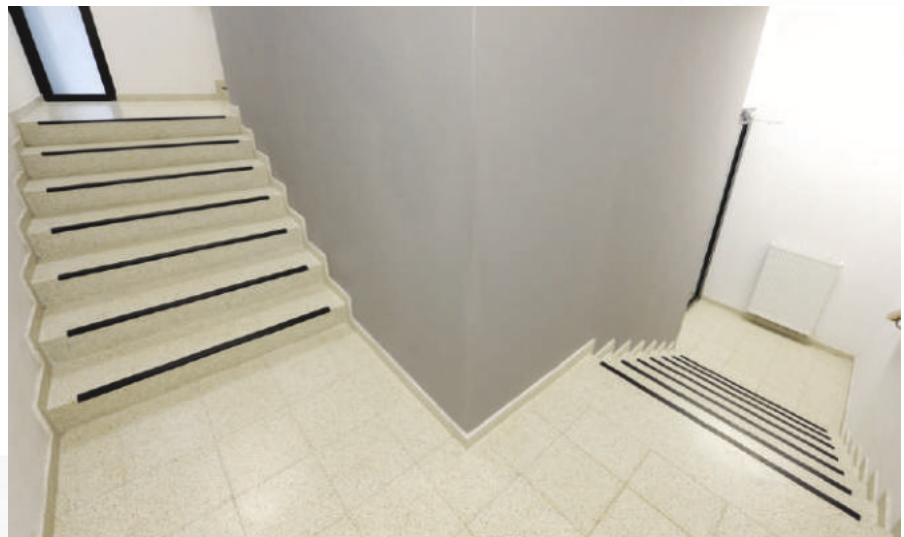

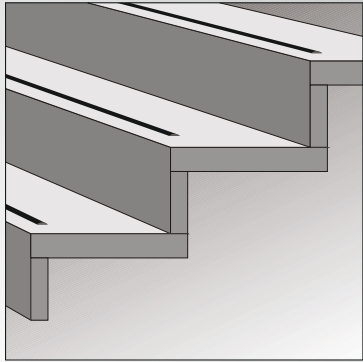

Single-breasted insert TYPE Hanno 500

The highly effective single-row anti-slip insert consists of a built-in PVC profile and studded rubber insert, which can be freely replaced. It is possible to make a stainless steel insert.

INSERTS AND PLINTHS TYPES

Double row insert TYPE Hanno 1000

Non-slip inserts incorporated into the step in two parallel rows during the production process. The embedded PVC profile and the rubber mushroom mounted to it are an ideal solution to prevent slipping. The rubber insert is available in many colors and can be easily replaced after years of use if necessary. It is possible to make a stainless steel insert.

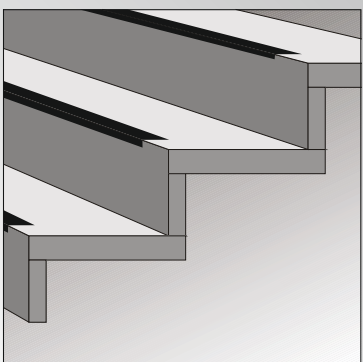
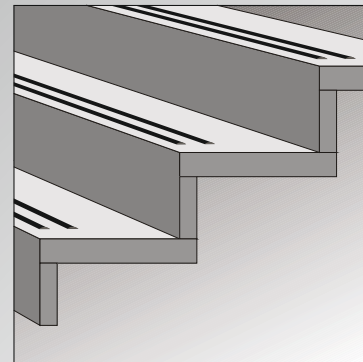

Corner insert - contrast (PVC or terrazzo)

Corner contrast and protective insert. Depending on the needs, it can play a protective role for the corner parts of the steps, as well as anti-slip and contrasting. This insert can be made of artificial material and concrete contrasting with the color of the steps.

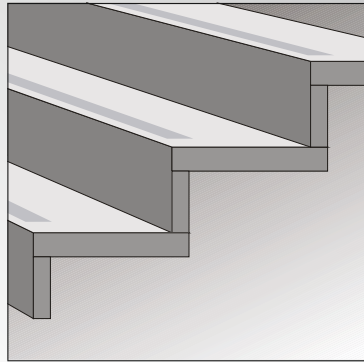

Sandblasted strip

The 4 cm wide sandblasted strip along the entire or part of the step length fulfills an anti-slip task due to high roughness.

Step plinth

Made of flooring material, adjusted to the width and height of the steps, chamfered on the edges, available as standard in a height of 71 mm.

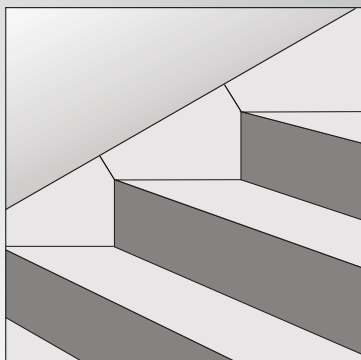
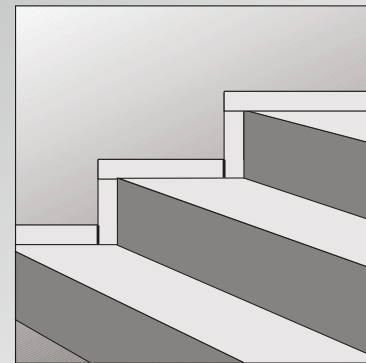

Plinth TYPE bishop's cap

The plinth, adapted to the width and height of the steps, has a shape typical for a bishop's cap and creates one line parallel to the stair run.



FACADES

FACADES

Aesthetics, easy and quick assembly are the advantages of facade panels. A wide range of colors, a variety of surface finishes and the ability to produce tiles in any shape and size allows you to optimally match the material to the needs of the project and the investor's expectations. In our offer you will also find additional facade elements, such as cornices, window sills, reveal elements manufactured to individual order.



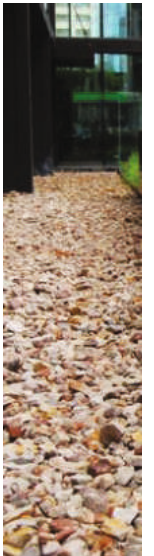
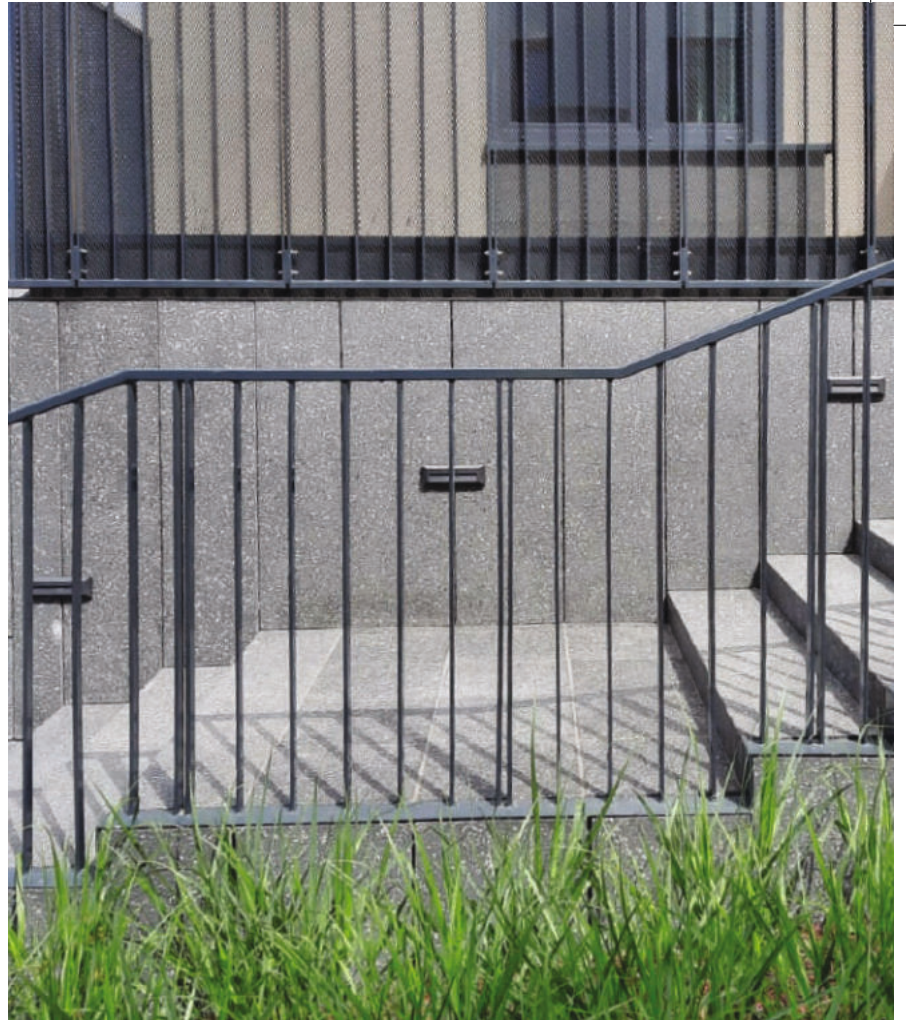
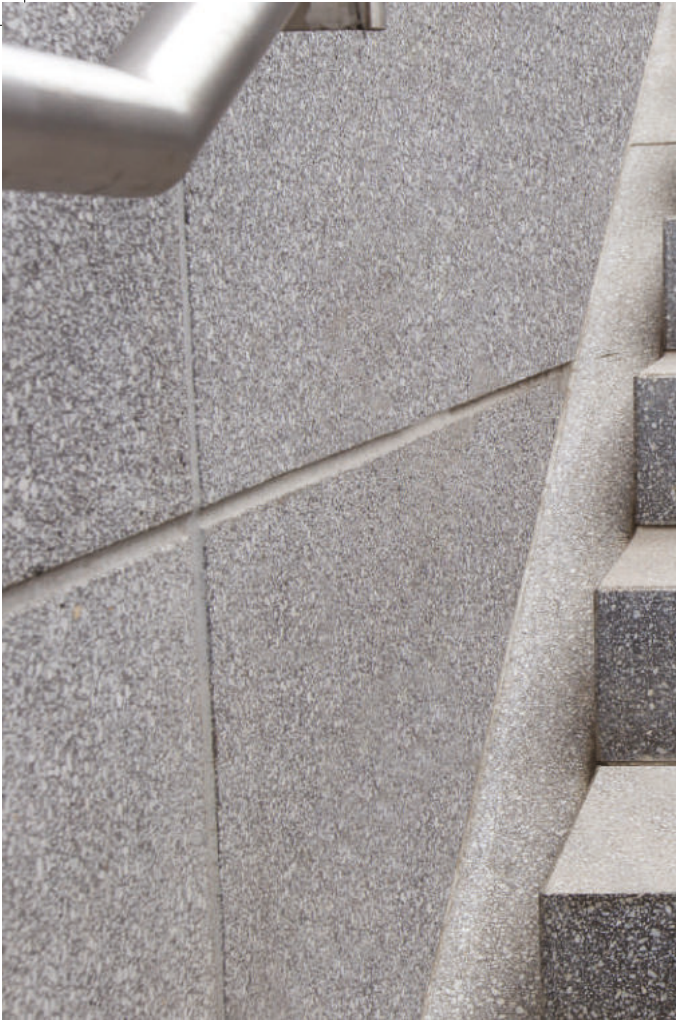

WALL CLADDING, CORNICES, WINDOW SILLS



WALL CLADDING

Terrazzo is a timeless facade material. A wide range of textures encourages creativity, and the natural color palette in a subtle way blends in with the surroundings, emphasizing its beauty. Available in many formats, it is perfect as a cladding for stable surfaces, from facade walls to fence elements.



SMALL ARCHITECTURE

In our offer you will find products that allow for effective arrangement of compositions in city squares, gardens, parks, and around houses. Walls, fences, benches, flower beds - even the smallest element of the landscape can gain an aesthetic and original finish.

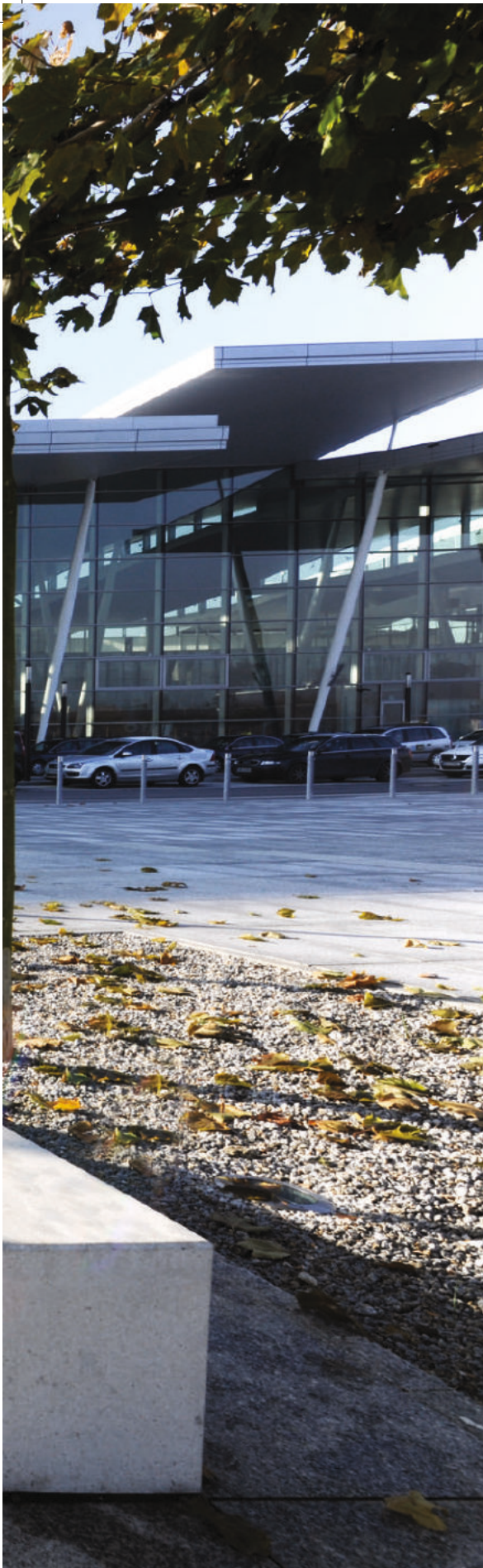

PROBET-DASAG products are distinguished by high quality and adherence to both aesthetics and utility values. Our products are used in industrial construction, prestigious public investments, as well as individual housing projects. In order to meet the growing expectations of our customers, we consistently develop our product offer, taking care to diversify the assortment, and at the same time the comprehensiveness of the offer. Thanks to the unlimited possibilities of using terrazzo, the richness of colors and shapes flowing from nature, which makes it possible to obtain intriguing combinations of colors, textures and forms, we meet the most daring concepts of architects. Care for expanding the product offer and its high quality also includes a responsible approach to environmental protection. Thanks to the actions taken, we have significantly reduced energy consumption and improved the water recycling system used in the production process. Economies of scale and optimization of production processes, taking into account pro-environmental activities allow us to offer the highest quality products at a reasonable price.

Feel free to contact our office!

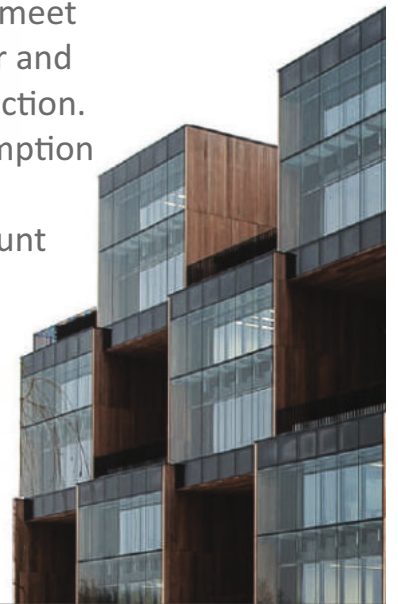



PROBET-DASAG SP. Z O.O.
UL. FABRYCZNA 4-6
68-100 ŻAGAŃ
TEL. +48 68 363 16 28
FAX +48 68 363 16 58
E-MAIL: HANDEL@DASAG.EU

WWW.DASAG.EU

