



Sp@ce-Concept

play-work-sleep



Mini Länge 206 cm, Breite 97 cm, Höhe 120 cm
 Longueur, Largeur, Hauteur
 Length, Width, Height

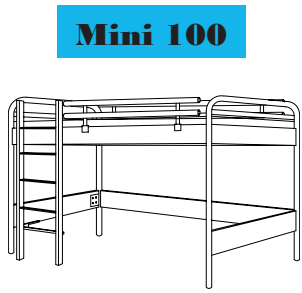

Mini 100



Mini 102



Mini 103



Mini 104



Maxi 112



Maxi 113



Maxi 114



Maxi 115



Maxi Länge 206 cm, Breite 97 cm, Höhe 175 cm
 Longueur, Largeur, Hauteur
 Length, Width, Height

Die Auswahl

Le Choix

The Choice



Maxi 116



Maxi 117



Maxi 118



Midi Länge 206 cm, Breite 97 cm, Höhe 148 cm
 Longueur, Largeur, Hauteur
 Length, Width, Height



Midi 105

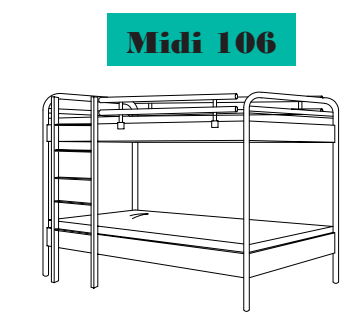

Midi 106



Midi 107

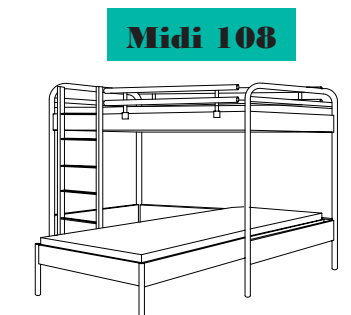

Midi 108



XL 119



XL 120



XXL 121



XXL 122



XL/XXL Länge 209 cm, Breite 130 cm + 150 cm, Höhe XL=180 cm, XXL=200 cm
 Longueur, Largeur, Hauteur
 Length, Width, Height

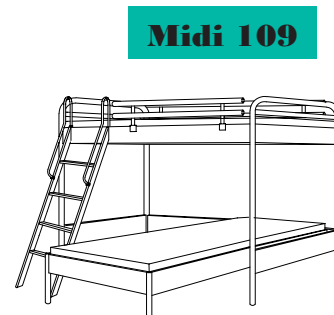

Midi 109

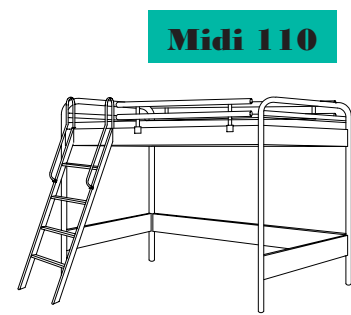

Midi 110

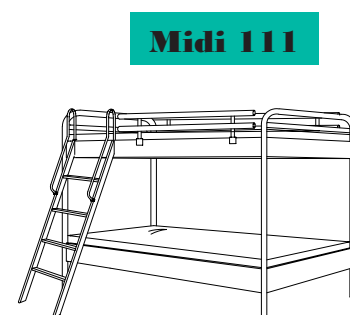

Midi 111

Farben für alle Modelle
 Couleurs pour tous les modèles
 Colours for all models

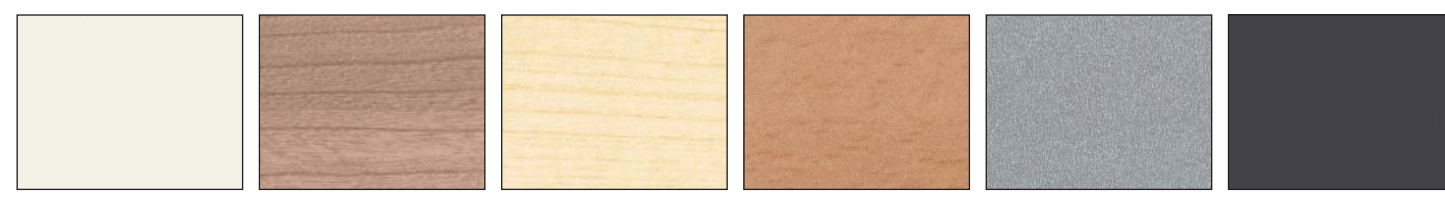

Weiss Blanc White, Noce, Ahorn Erable Maple, Buche Hêtre Beech, Eisenfarbig Teinté fer Ironcoloured, Anthrazit Anthracite



GS Geprüfte Sicherheit ist das Zeichen für Funktionssicherheit von Möbeln (und anderen Gebrauchsartikeln). Wird von unabhängigen, vom Bundesarbeitsministerium zugelassenen Prüfstellen vergeben. Geprüft wird immer die Gesamt-Sicherheit eines Möbelstückes.
 Die Sp@ce-Concept-Betten Mini, Midi, Maxi – XL und XXL wurden nach **DIN-EN 747-1** und **DIN EN 747-2** gebaut und geprüft.
 Wir wollen unsere Produkte den sich laufend veränderten Sicherheitsnormen anpassen. Deshalb können die gelieferten Produkte leicht von den gezeigten Abbildungen abweichen.

GS Une sécurité testée signifie une sécurité fonctionnelle du meuble (et autres accessoires). Ce certificat est délivré par un organisme dépendant du ministère Allemand de l'Industrie, qui est chargé des contrôles de sécurité des meubles. Les lits du Sp@ce-Concept Mini, Midi, Maxi – XL et XXL correspondent aux normes **DIN EN 747-1** et **DIN EN 747-2**.
 Nous voulons adapter les normes de sécurité à nos produits qui sont constamment modifiés. Et de ce fait, les produits livrés peuvent avoir de légers écarts par rapport à nos illustrations.

GS Approved Safety – The German GS symbol given by the German Government-to appointed independent institutes. Furniture carrying this symbol ensures functionally and highest safety.
 The Sp@ce-Concept beds Mini, Midi, Maxi – XL and XXL are produced in compliance with the **DIN EN 747-1** and **DIN EN 747-2**.
 We do everything to keep our products up to date to suit the latest safety standards. For that reason the products actually supplied may differ slightly from the ones shown in the illustrations.



Die von uns verwendeten Holzwerkstoffe sind gemäss den strengen E1-Normen verleimt. Die Emissionen liegen somit unter den gesetzlich festgelegten Grenzwerten.

Le collage des matériaux à base de bois que nous utilisons est effectué conformément aux sévères normes E1. Ainsi, les émissions sont inférieures aux valeurs limites fixées par la loi.

The wood that we use is laminated in compliance with the stringent E1 Standard. This means that the emissions lie below the statutorily defined limits.

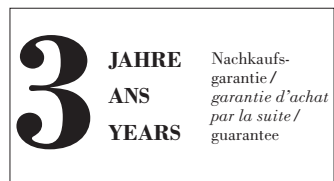

Nachkaufsgarantie 3 Jahre
 Das Sp@ce-Concept lässt sich laufend an Ihre Bedürfnisse anpassen. Um dies sicherzustellen geben wir Ihnen eine Nachkaufsgarantie von 3 Jahren auf sämtliche Teile.

Garantie d'achat de 3 ans
 Le Sp@ce-Concept permet une adaptation continue de vos besoins. Nous vous garantissons la possibilité d'achat de pièces supplémentaires pendant 3 ans.

Supply guarantee for repeat purchases
 The Sp@ce-Concept can always be adapted to meet your current needs. We ensure this by giving you a 3 years guarantee on all the parts.

Sp@ce-Concept Betten wachsen mit – Ergänzungssätze können nachträglich bezogen werden!
Les lits Sp@ce-Concept suivent la croissance – sets complémentaires à commander séparément!
The Sp@ce-Concept beds that follow your growth – extension parts are also available individually!

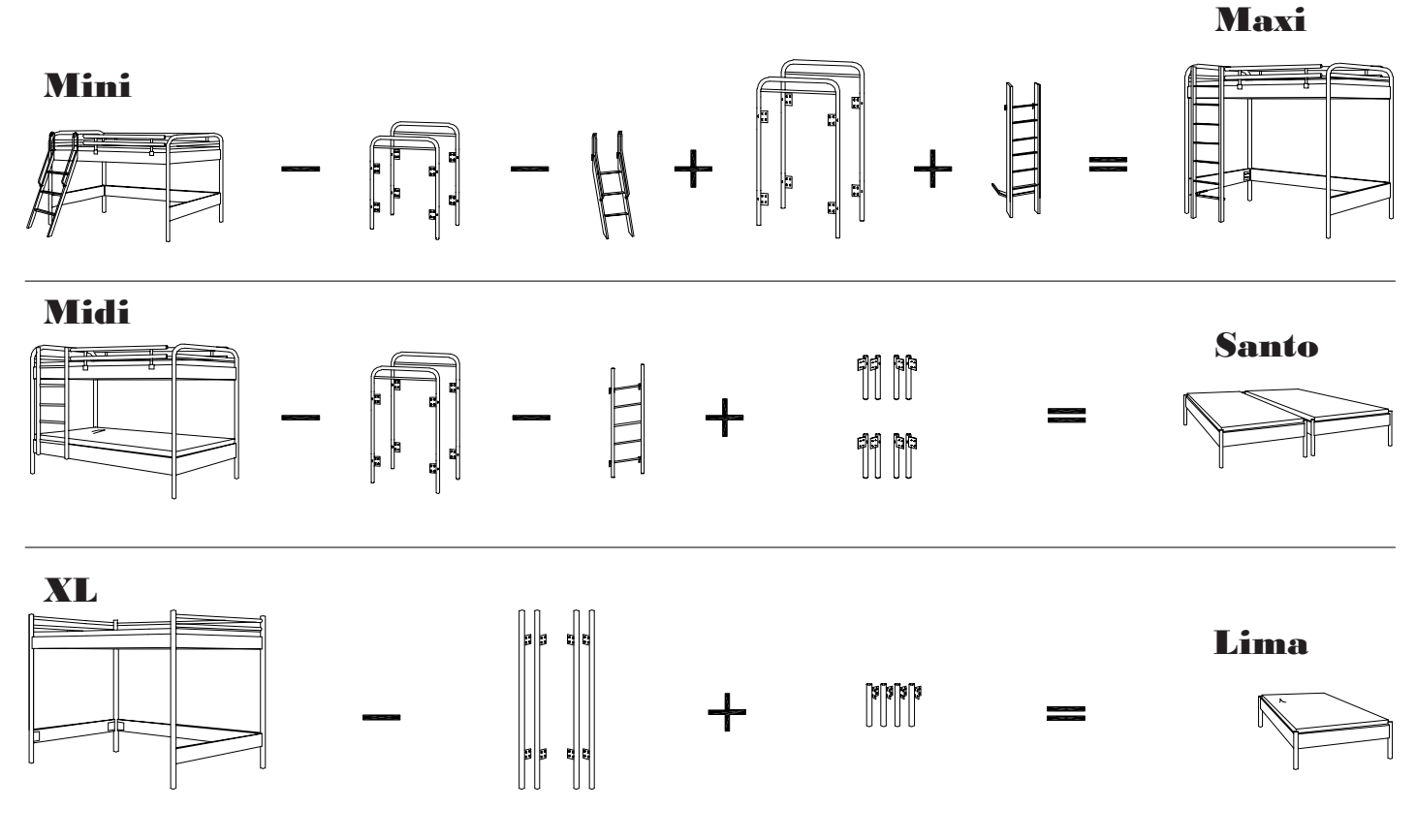

Santo
 Nur mit 4 zusätzlichen Füßen Santo kann aus Modell Mini, Midi, Maxi das Einzelbett Santo gebaut werden.
Les lits Mini, Midi, Maxi peuvent être changés en lits individuels Santo. Montage uniquement possible avec 4 pieds Santo.
 With 4 additional feet Santo it is possible to convert the Mini, Midi, Maxi into one individually Santo bed.

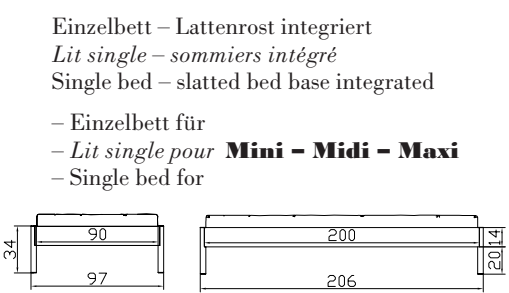

Lima
 Nur mit 4 zusätzlichen Füßen Lima kann aus Modell XL, XXL das Einzelbett Lima gebaut werden.
Les lits XL, XXL peuvent être changés en lits individuels Lima. Montage uniquement possible avec 4 pieds Lima.
 With 4 additional feet Lima it is possible to convert the XL, XXL into one individually Lima bed.

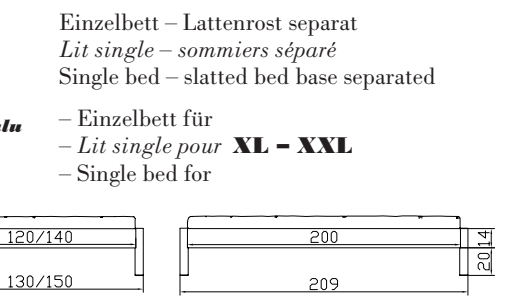

Mini

11 Tisch/table/table Mini



11 Anbautisch/table juxtaposée/ side table Mini



12 Regalhalter/ support étagère/ shelf bracket Mini



14 Flower = Stirnseite/pan frontal/front part 1 Stk. inkl. Vorhangstange 1 pce tringle inclus 1 pce with curtain rail included



15 Camp = Längsseite/pan latéral/side part 1 Stk. inkl. Vorhangstange 1 pce tringle inclus 1 pce with curtain rail included



16 Beach = Stirnseite/pan frontal/front part 1 Stk. inkl. Vorhangstange 1 pce tringle inclus 1 pce with curtain rail included



17 Ball = Stirnseite/largepans/front part 1 Stk. inkl. Vorhangstange 1 pce tringle inclus 1 pce with curtain rail included

18 Boat = Längsseite/pan latéral/side part 1 Set (2 Stk.) inkl. Vorhangstange 1 set (2 pces) tringle inclus 1 set (2 pces) with curtain rail included



Match = Längsseite/pan latéral/side part 1 Set (2 Stk.) inkl. Vorhangstange 1 set (2 pces) tringle inclus 1 set (2 pces) with curtain rail included

19

86 Dream = Stirnseite/pan frontal/front part 1 Stk. inkl. Vorhangstange 1 pce tringle inclus 1 pce with curtain rail included



88 Lovely = Längsseite/pan latéral/side part 1 Set (2 Stk.) inkl. Vorhangstange 1 set (2 pces) tringle inclus 1 set (2 pces) with curtain rail included



90 Kids Club = Stirnseite/pan frontal/front part 1 Stk. inkl. Vorhangstange 1 pce tringle inclus 1 pce with curtain rail included



92 Numero = Längsseite/pan latéral/side part 1 Set (2 Stk.) inkl. Vorhangstange 1 set (2 pces) tringle inclus 1 set (2 pces) with curtain rail included



Vorhangstange auch separat erhältlich/tringle est aussi disponible séparément/curtain rail also available separately

Crown = Kissen/coussins/cushion Dimension: 40x40cm



One = Kissen/coussins/cushion Dimension: 40x40cm



Rückseite Au verso Back side

Rückseite Au verso Back side

Sit = Kissen/coussins/cushion Dimension: 40x40cm



Sit = Kissen/coussins/cushion Dimension: 40x40cm



Neck = Kissen/coussins/cushion Dimension: 30x50cm



Neck = Kissen/coussins/cushion Dimension: 30x50cm



Kissen
Stoffmaterial: 100% Baumwolle
Füllung: 100% Polyester
waschbar 30°C

Coussins
Material de tissu: 100% coton
Rembourrage: 100% polyester
Lavable 30°C

Cushion
Material of tissue: 100% cotton
Filling: 100% polyester
Washable 30°C

Midi

12 Tisch/table/table Midi



23 Anbautisch/table juxtaposée/ side table Midi



24 Regalhalter/ support étagère/ shelf bracket Midi



12 Tisch/table/table Maxi



33 Anbautisch/table juxtaposée/ side table Maxi



34 Regalhalter/ support étagère/ shelf bracket Maxi



25 Window = Stirnseite/pan frontal/front part 1 Stk. inkl. Vorhangstange 1 pce tringle inclus 1 pce with curtain rail included



26 Circus = Längsseite/pan latéral/side part 1 Set (2 Stk.) inkl. Vorhangstange 1 set (2 pces) tringle inclus 1 set (2 pces) with curtain rail included



84 Sea = Stirnseite/pan frontal/front part 1 Stk. inkl. Vorhangstange 1 pce tringle inclus 1 pce with curtain rail included



85 Navy = Längsseite/pans latéral/side part 1 Set (2 Stk.) inkl. Vorhangstange 1 set (2 pces) tringle inclus 1 set (2 pces) with curtain rail included

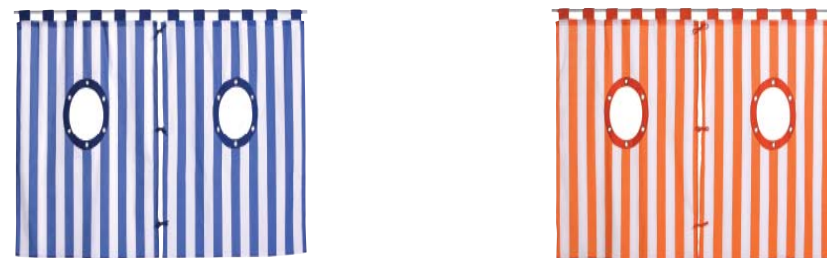

Alle Vorhänge zu Mini/Midi/Maxi sind aus 100% Baumwolle./Tous les rideaux pour Mini/Midi/Maxi sont en 100% coton./All curtains to Mini/Midi/Maxi are of 100% cotton.

Midi

Shopy Midi Shopy Maxi

- 30** **Shopy** = Stirnseite
Komplett inklusive
1 Vordach
1 Regalhalter-Set
1 Regalboden 30 weiss
1 Stoff-Set (2 Stk.)
1 Schild (Marché/Café)
1 Schild neutral
- Shopy** = pan frontal
complet comprenant
1 auvent
1 set de support étagère
1 étagère 30 blanche
1 set tissu (2 pces)
1 panneau (Marché/Café)
1 panneau neutre
- Shopy** = front part
Complete including
1 shelf bracket
1 shelf 30 white
1 set of tissues (2 pces)
1 shield (Marché/Café)
1 shield neutral



Maxi

Theater Midi Theater Maxi

- 32** **Theater** = Stirnseite
Komplett inklusive
1 Vorhanghalter
1 Regalhalter-Set
1 Regalboden 30 weiss
1 Stoff-Set (4 Stk.)
1 Schild
(Theater/Cinéma)
1 Schild neutral
- Theater** = largepans
complet comprenant
1 support rideau
1 set de support étagère
1 étagère 30 blanche
1 set tissu (4 pces)
1 panneau
(Theater/Cinéma)
1 panneau neutre
- Theater** = front part
Complete including
1 curtain bracket
1 set of shelf bracket
1 shelf 30 white
1 set of tissues (4 pces)
1 shield
(Theater/Cinéma)
1 shield neutral



- 31** **Store** = Längsseite
1 Set (2 Stk.) inkl. Vorhangstange
- Store** = pan latéral
1 set (2 pces) tringle inclus
- Store** = side part
1 set (2 pces) with curtain rail included



- 33** **Concert** = Längsseite
1 Set (2 Stk.) inkl. Vorhangstange
- Concert** = pan latéral
1 set (2 pces) tringle inclus
- Concert** = side part
1 set (2 pces) with curtain rail included



- 28** **Goal** =
Stirnseite/pan frontal/front part
1 Stk. inkl. Vorhangstange
1 pce tringle inclus
1 pce with curtain rail included



- 29** **Game** =
Längsseite/pan latéral/side part
1 Set (2 Stk.) inkl. Vorhangstange
1 set (2 pces) tringle inclus
1 set (2 pces) with curtain rail included

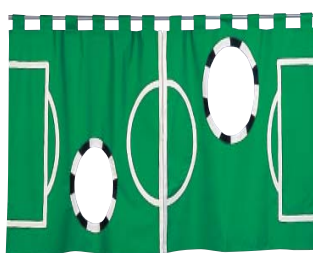

- 37** **Princess** =
Stirnseite/pan frontal/front part
1 Stk. inkl. Vorhangstange
1 pce tringle inclus
1 pce with curtain rail included



- 39** **Pretty** =
Längsseite/pan latéral/side part
1 Set (2 Stk.) inkl. Vorhangstange
1 set (2 pces) tringle inclus
1 set (2 pces) with curtain rail included



- 31** **Kidy** =
Stirnseite/largepan/front part
1 Stk. inkl. Vorhangstange
1 pce tringle inclus
1 pce with curtain rail included



- 33** **Count** =
Längsseite/pan latéral/side part
1 Set (2 Stk.) inkl. Vorhangstange
1 set (2 pces) tringle inclus
1 set (2 pces) with curtain rail included



- Crown** =
Kissen/coussins/cushion
Dimension: 40x40cm



- Rückseite
Au verso
Back side

- Sit** =
Kissen/coussins/cushion
Dimension: 40x40cm



- Kissen**
Stoffmaterial: 100% Baumwolle
Füllung: 100% Polyester
waschbar 30°C

- Coussins**
Material de tissu: 100% coton
Rembourrage: 100% polyester
Lavable 30°C

- Cushion**
Material of tissue: 100% cotton
Filling: 100% polyester
Washable 30°C

- Neck** =
Kissen/coussins/cushion
Dimension: 30x50cm



- One** =
Kissen/coussins/cushion
Dimension: 40x40cm



- Rückseite
Au verso
Back side

- Sit** =
Kissen/coussins/cushion
Dimension: 40x40cm



- Neck** =
Kissen/coussins/cushion
Dimension: 30x50cm



Mini - Midi - Maxi

**Lattenrost immer integriert
Sommier toujours intégré
Slatted bed base always integrated**



...mit 18 Buchenschichtholz-Federleisten,
7-fach verleimt, mit PVC-Kappen geräuschlos
gelagert, Längsholme MDF foliert.

...avec 18 lattes en hêtre multiplis, collées en
sept couches de placage, isolées phoniquement
par des embouts PVC, longpans en MDF
laminé.

...with 18 slats in beech veneer, sevenfold
glued and silent supported in elements of PVC,
sideboard in MDF laminated.

XL / XXL

- 43** Tisch/table/table XL + XXL



- 33** Anbautisch/
table juxtaposée/
side table XL + XXL



- 34** Regalhalter/
support étagère/
shelf-bracket
XL + XXL



- 64** Duostar X Lattenrost/sommier/
slatted bed base



- 34 Buchenschichtholz-Federleisten
in PVC-Kappen geräuschlos gelagert,
Längsholme Buche schichtverleimt
- 34 lattes en hêtre multiplis, isolées
phoniquement par des embouts PVC,
longpans en hêtre multiplis.
- 34 slats in beech plywood and silent
supported in elements of PVC, side
boards in beech plywood

Masse/Dimensions 120/200, 140/200

Achtung: Bei XL/XXL ist der Lattenrost nicht integriert. **Die Sicherheitsgewährung für die Modelle XL + XXL nach DIN-EN 747-1 + DIN 747-2 hat nur im Zusammenhang mit dem Hasena Lattenrost Duostar X Gültigkeit.**

Attention: Pour XL/XXL le sommier n'est pas intégré. **La sécurité des lits XL et XXL correspondant aux normes DIN EN 747-1 et DIN EN 747-2 est uniquement garanti avec l'utilisation du sommier Duostar X de Hasena.**

Attention: For XL/XXL and Lima beds the slatted bed base is not an integrated part. **According to DIN EN-747-1 and DIN EN 747-2, the safety guarantee for the beds XL and XXL is only valid in connection with proper usage of the Hasena Duostar X slatted bed base.**

Anwendungsbeispiele mit Anbautisch + Regalhalter/Exemple d'utilisation avec une table juxtaposée et support étagère/Application possibilities with side table and shelf bracket

Regalbox S nicht mit anderen Tei-
len kombinierbar/
étagère-box S n'est pas compatible
avec d'autres accessoires/
shelf-box S cannot be combined
with other parts

Regalbox L mit Regalboden
16 und 30 kombinierbar/
étagère L compatible avec
étagères 16 et 30/
shelf-box L can be combined
with shelf 16 and 30

Anbautisch mit Tafel nur bei Versi-
on Maxi, XL + XXL möglich/
Table juxtaposée avec tableau
seulement pour Maxi, XL et
XXL/
Side table with magnetic drawing
board is only available with Maxi,
XL + XXL

Regalbox L mit Regalboden
16 und 30 kombinierbar/
étagère L compatible avec
étagères 16 et 30/
shelf-box L can be combined
with shelf 16 and 30

1 x Tafel für alle Grössen
passend/
1 x tableau pour tous les
modèles/
1 x board fits all models

2 x Tafel nur für Maxi,
XL + XXL/
2 x tableaux seulement
avec Maxi, XL + XXL/
2 x boards only available
for Maxi, XL + XXL

Ohne Magnete/
sans aimants/
without magnets

Ohne Magnete/
sans aimants/
without magnets



Zubehör für alle Größen/Accessoires pour tous les grandeurs//Accessories for all dimensions

45 Hängeregal/
étagère à suspendre/
suspension shelf
70/14 cm

59 Regalboden 30/
étagère 30/
shelf 30
83/30 cm

58 Regalboden 16/
étagère 16/
shelf 16
83/16 cm

60 Regalbox S/
étagère S/
shelf S
32/14/6 cm

74 Regalbox L/
étagère L/
shelf L
82/14/6 cm

61 Bücherstützen/
serre-livres/
book end

47 Mal-Magnettafel (benötigt
immer Regalhalter)
tableau magnétique
(nécessite toujours des
supports pour étagères)
magnetic drawing board
(needs always shelf-
bracket)
Ohne Magnete/
sans aimants/
without magnets
80/48/2 cm

62 90 cm

63 120 cm

64 140 cm

Kleiderstange/
tringle/
clothes rail

71 106/32 cm

72 150/32 cm

73 194/32 cm

Erhöhte Absturzicherung/
barrière de sécurité surélevé/
elevated safetyrail

65 Nackenrolle Cosy/
pelochon Cosy/
neck roll Cosy

Baumwolle/coton/cotton

Kunstleder/cuir synthétique/synthetic leather

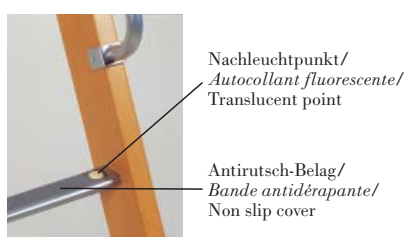

66 **Sicherheitspaket/Paquet de sécurité/Safety package**
Zum Schutz Ihrer Kinder gibt es pro Modell ein Sicherheitspaket. Selbstklebende Streifen zum Anbringen auf der Treppe/Leiter vermindern das Rutschen und die selbstklebenden Punkte leuchten im Dunkeln.
Pour la sécurité de vos enfants nous vous proposons une protection supplémentaire par modèle. Les bandes adhésives à coller sur les échelles et escaliers sont antidérapantes et les autocollants fluorescents.
For each model there is a safety package available to protect the children. Self adhesive strips to attach on the stair/ladder to avoid sliding and translucent points to shine in the dark.

Basic

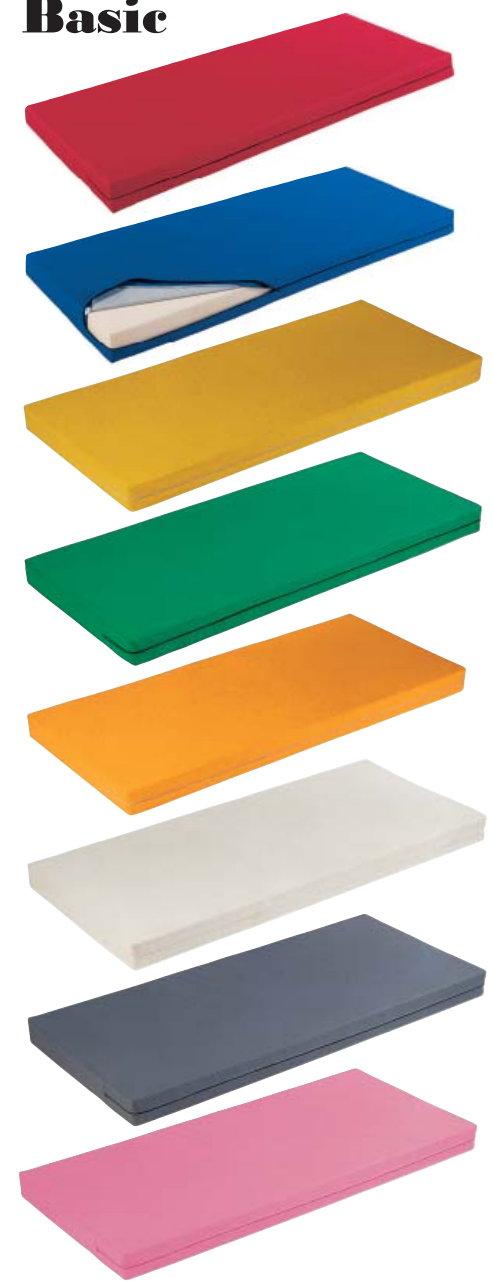

67 Matratze/*matelas/*mattress

- Kern aus Polyätherschaum RG 25, mit Vlies
- Bezug 100% Baumwolle
red 18, light blue 67, yellow 66, green 19, orange 13, écru 63, silvergrey 69 oder pink 208
- abnehmbar mit Reissverschluss, waschbar
- *noyau en polyéther, densité 25, avec rembourrage*
- *housse 100% coton*
red 18, light blue 67, yellow 66, green 19, orange 13, écru 63, silvergrey 69 ou pink 208
- *amovible avec fermeture à glissière, lavable*
- foam core, density 25, with non woven
- cover 100% cotton
red 18, light blue 67, yellow 66, green 19, orange 13, écru 63, silver grey 69 or pink 208
- removable with zip, washable

Masse/Dimensions/cm

90/200
100/200
120/200
140/200
160/200

Pully

Ausziehbett – Lattenrost integriert
Lit gigogne – sommiers intégré
Pull-out bed – slatted bed base integrated



Farben: Buche Nachbildung Ahorn Nachbildung Eisenfarbig Weiss	Couleurs: laminé hêtre laminé érable teinté fer blanc	Colours: Laminated beech Laminated maple Ironcoloured White
---	---	---

Clic

Aufklappbett – Lattenrost integriert
Lit jumelés – sommiers intégré
Bed to open – slatted bed base integrated



Farben: Buche Nachbildung Ahorn Nachbildung Eisenfarbig Weiss	Couleurs: laminé hêtre laminé érable teinté fer blanc	Colours: Laminated beech Laminated maple Ironcoloured White
---	---	---

Details siehe Seite/détails voir page/details see page 7.30 – 7.31



Vito

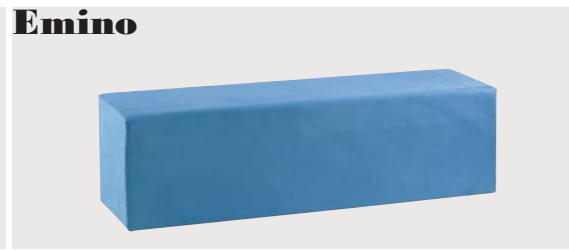

Emino



Hoc Antirutsch Unterlage (Netz) inkl./filet antiglisse inclus/antiglide net included



Banc Antirutsch Unterlage (Netz) inkl./filet antiglisse inclus/antiglide net included



Pero ★



Arese ★



Twin*

Trio*

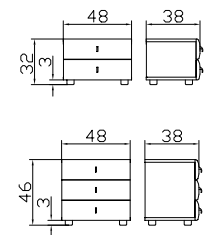
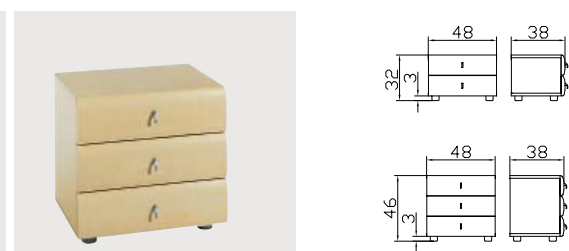

Calino*

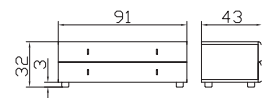
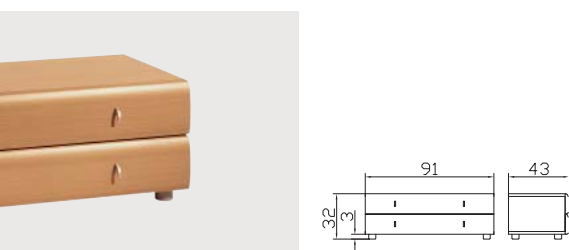

Box



Emilio

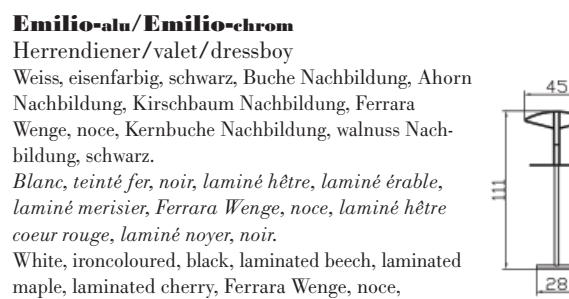

Emilio-alu/Emilio-chrom
Herrendiener/valet/dressboy
Weiss, eisfarbenig, schwarz, Buche Nachbildung, Ahorn Nachbildung, Kirschbaum Nachbildung, Ferrara Wenge, noce, Kernbuche Nachbildung, walnuss Nachbildung, schwarz.
Blanc, teinté fer, noir, laminé hêtre, laminé érable, laminé merisier, Ferrara Wenge, noce, laminé hêtre coeur rouge, laminé noyer, noir.
White, ironcoloured, black, laminated beech, laminated maple, laminated cherry, Ferrara Wenge, noce, laminated heart beech, laminated walnut, black.

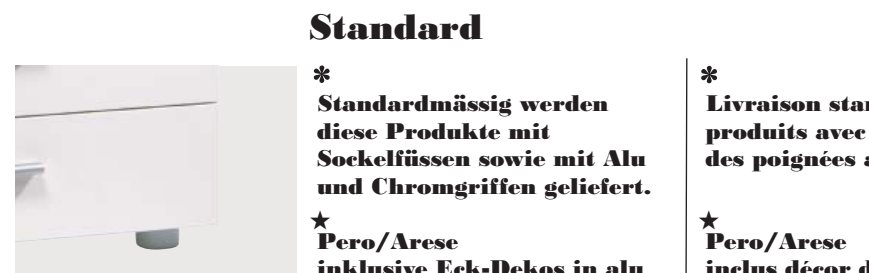
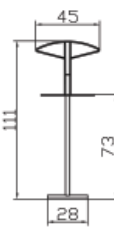

Standard

* Standardmässig werden diese Produkte mit Sockelfüssen sowie mit Alu und Chromgriffen geliefert.

★ Pero/Arese inklusive Eck-Dekos in alu und chrom

* Livraison standard de ces produits avec des socles et des poignées alu et chrome.

★ Pero/Arese inclus décor d'angles en alu et chrome

* Products supplied in standard version with base legs and also with alu and chrome handles.

★ Pero/Arese including deco corners in alu and chrome



Option*

Leg-alu/Leg-chrom
Fuss-Set/set de pieds/set of feet
Dimension/cm
8/4



Vito Hocker/tabouret/stool
Emino Bank/banquette/bench
Material und Farbe siehe Seite 1.07
Matière et couleurs voir page 1.07
Material and colours look page 1.07

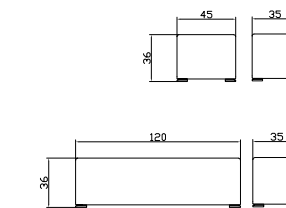

Hoc Kissen/coussin/cushion
Banc Kissen/coussin/cushion
Material und Farbe siehe Seite 1.07
Matière et couleurs voir page 1.07
Material and colours look page 1.07

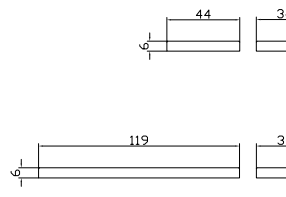

Pero Hocker/tabouret/stool
Arese Bank/banquette/bench
Weiss, eisfarbenig, Kirschbaum Nachbildung, Buche Nachbildung, Ahorn Nachbildung, Ferrara Wenge
Blanc, teinté fer, laminé merisier, laminé hêtre, laminé érable, Ferrara Wenge
White, ironcoloured, cherrycoloured, laminated beech, laminated maple, Ferrara Wenge

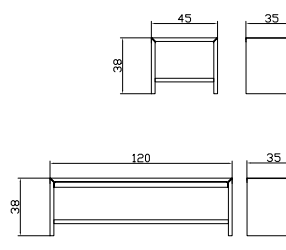

Twin Nachttisch/table de nuit/bedside table
Trio/Ossono Kommode/commode/chest of drawers
Weiss, eisfarbenig, Kirschbaum Nachbildung, Buche Nachbildung, Ahorn Nachbildung, noce, Ferrara Wenge, Kernbuche Nachbildung, walnuss Nachbildung, schwarz.
Blanc, teinté fer, laminé merisier, laminé hêtre, laminé érable, noce, Ferrara Wenge, laminé hêtre coeur rouge, laminé noyer, noir.
White, ironcoloured, cherrycoloured, laminated beech, laminated maple, noce, Ferrara Wenge, laminated heart beech, laminated walnut, black.

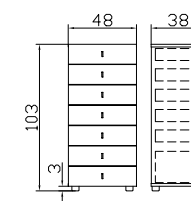

Calino/Cassana
Kommode/commode/chest of drawers
Weiss, eisfarbenig, Buche Nachbildung, Ahorn Nachbildung, Kirschbaum Nachbildung, noce, Ferrara Wenge, Kernbuche Nachbildung, walnuss Nachbildung, schwarz.
Blanc, teinté fer, laminé hêtre, laminé érable, laminé merisier, noce, Ferrara Wenge, laminé hêtre coeur rouge, laminé noyer, noir.
White, ironcoloured, laminated beech, laminated maple, laminated cherry, noce, Ferrara Wenge, laminated heart beech, laminated walnut, black.

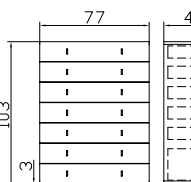

Box Bettkasten/tiroir/drawer
Weiss, Buche Nachbildung, Ahorn Nachbildung, Kirschbaum Nachbildung, eisfarbenig, Ferrara Wenge, noce, Kernbuche Nachbildung, walnuss Nachbildung, schwarz.
Blanc, laminé hêtre, laminé érable, laminé merisier, teinté fer, Ferrara Wenge, noce, laminé hêtre coeur rouge, laminé noyer, noir.
White, laminated beech, laminated maple, laminated cherry, ironcoloured, Ferrara Wenge, noce, laminated heart beech, laminated walnut, black.

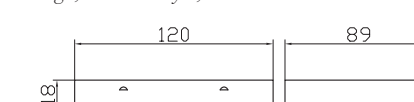

Box + Cover (Option)



Cover (Option)
Deckel zu Box nur in weiss
Couvercle pour Box uniquement en blanc
Cover to Box only in white

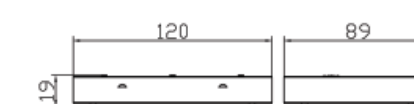



**Cosy
Dream
Lovely
Crown**

Nackenrolle
Vorhang Stirnseite
Vorhang Längsseite
Kissen

Pelochon
Rideau frontal
Rideau pans latéral
Coussin

Neckroll
Curtain front part
Curtain side part
Cushion

Dimension/cm
48/15
89/83
197/83
40/40

**Mini Spielbett
mit Treppe**
Ahorn Nachbildung

Trio Nachttisch
Ahorn Nachbildung

**Mini lit mezza-
nine avec escalier**
Laminé érable

Trio table de nuit
Laminé érable

**Mini loft bed
with stairs**
Laminated maple

Trio bedside table
Laminated maple

Dimension/cm
90/200

48/46/38





Mini Spielbett mit Holzleiter Noce

Mini Spielbett mit Treppe
Ahorn Nachbildung

Beach Vorhang
Stirnseite

Boat Vorhang
Längsseite Baumwolle
blue/white 206

Calino Kommode
Noce

Vito Hocker
Bonova sky 408

Cosy Nackenrolle
Baumwolle yellow 66

Flower Vorhang
Stirnseite

Camp-Vorhang
Längsseite

Baumwolle red 18

Ossono Kommode

Tisch Mini 90
Ahorn Nachbildung

7.16

Mini lit mezzanine avec échelle en bois Noce

Mini lit mezzanine avec escalier
Laminé érable

Beach rideau
pan frontal

Boat rideau
pan latéral coton
blue/white 206

Calino commode
Noce

Vito tabouret
Bonova sky 408

Cosy tête pelochon
Coton yellow 66

Flower rideau
largepans

Camp-rideau
pan latéral

Coton red 18

Ossono commode

Table Mini 90
laminé érable

Mini loft bed with wooden ladder
Noce

Mini Loft bed with stairs
Laminated maple

Beach curtain
front part

Boat curtain
side part cotton
blue/white 206

Calino chest of drawers
Noce

Vito stool
Bonova sky 408

Cosy neckroll
Cotton yellow 66

Flower curtain
front part

Camp-curtain
side part

Cotton red 18

Ossono chest of drawers

Table Mini 90
laminated maple

Dimension/cm
90/200

90/200

89/83

197/83

91/32/43

45/36/35

48/15

89/83

197/83

48/103/38

90/65/53

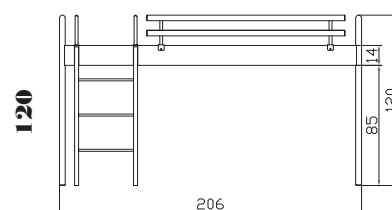
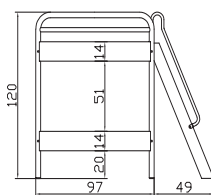
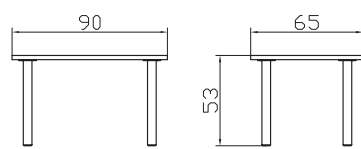

Mini Spielbett mit Holzleiter und Rutschbahn weiss

Beach Vorhang
Stirnseite
Boat Vorhang
Längsseite Baumwolle
orange/white 207

Cosy Nackenrolle
Baumwolle
orange/white 207

Vito Hocker
Baumwolle orange 13

Mini lit mezzanine avec échelle en bois et toboggan
blanc

Beach rideau
pan frontal
Boat rideau
pan latéral coton
orange/white 207

Cosy tête pelochon
Coton
orange/white 207

Vito tabouret
Coton orange 13

Mini loft bed with wooden ladder and slide
white

Beach curtain
front part
Boat curtain
side part cotton
orange/white 207

Cosy neckroll
Coton
orange/white 207

Vito stool
Coton orange 13

Dimension/cm

90/200

89/83

197/83

48/15

45/36/35

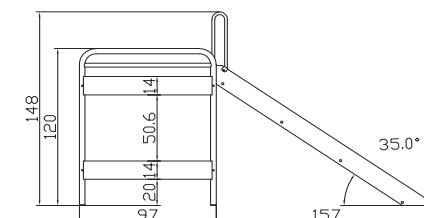
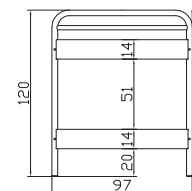



Pully

Ausziehbett
Nackenrolle
Vorhang Stirnseite
Vorhang Längsseite
Kissen
Hocker
Hängeregal

Lit jumelés
Pelochon
Rideau pan frontal
Rideau pan latéral
Coussin
Tabouret
Etagère à suspendre

Pull-out bed
Neckroll
Curtain front part
Curtain side part
Cushion
Stool
Suspension shelf

Dimension/cm
90/200
48/15
89/83
197/83
40/40
45/36/35
70/14/5

**Midi Etagenbett
mit Treppe**
Weiss

**Midi lit super-
posé avec escalier**
Blanc

**Midi bunk bed
with stairs**
White

Dimension/cm
90/200





Cosy Theater

Nackenrolle
Stirnseite komplett siehe
Seite 7.08

Concert Arese Banc

Vorhang Längsseite
Ablagetisch/Bank
Kissen
Hängeregal

Pelochon
Pan frontal complet voir
page 7.08

Rideau pan latéral
Table/banquette
Coussin
Etagère à suspendre

Neckroll
Front part complete see
page 7.08

Curtain side part
Table/bench
Cushion
Suspension shelf

Dimension/cm
48/15

197/111
120/36/35
119/6/34
70/14/5

Midi Hochbett mit Treppe
Noce

Ossono Kommode
Noce

Midi lit surélevé avec escalier
Noce

Ossono commode
Noce

Midi loft bed with stairs
Noce

Ossono chest of drawers
Noce

Dimension/cm
90/200

48/103/38



Midi Hochbett mit Holzleiter
weiss

Midi Hochbett mit Treppe Ahorn
Nachbildung

- Cosy** Nackenrolle
Shopy Midi Stirnseite
Komplett inklusive
1 Vordach
1 Regalhalter-Set
1 Regalboden 30 weiss
1 Stoff-Set (2 Stk.)
1 Schild (Marché/Café)
1 Schild neutral
Store Vorhang
Längsseite Baumwolle
orange/white 207
blue/white 206

- Vito** Hocker
Baumwolle orange 13
Baumwolle light blue 67

Midi lit surélevé avec échelle en bois
blanc

Midi lit surélevé avec escalier laminé
érable

- Cosy** tête pelochon
Shopy Midi pan frontal
complet comprenant
1 avant
1 set de support étagère
1 étagère 30 blanche
1 set tissu (2 pces)
1 panneau (Marché/Café)
1 panneau neutre
Store rideau
pan latéral coton
orange/white 207
blue/white 206

- Vito** tabouret
Coton orange 13
Coton light blue 67

Midi loft bed with wooden ladder
white

Midi loft bed with stairs
Natural maple

- Cosy** neckroll
Shopy Midi front part
Complete including
1 marquee
1 shelf bracket
1 shelf 30 white
1 set of tissues (2 pces)
1 shield (Marché/Café)
1 shield neutral
Store curtain
side part cotton
orange/white 207
light blue/white 206

- Vito** stool
Cotton orange 13
Cotton light blue 67

Dimension/cm
90/200

90/200

48/15

197/111

45/36/35

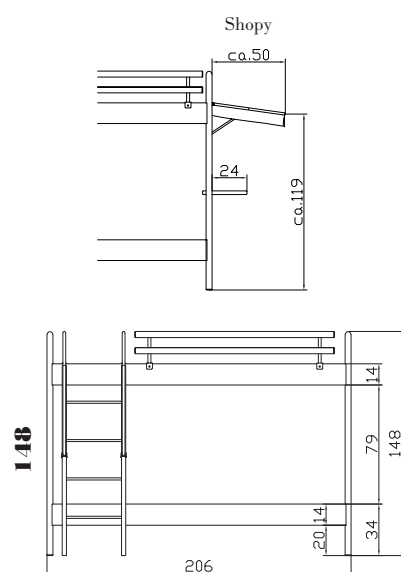

Midi Hochbett mit Holzleiter
Buche Nachbildung

- Cosy** Nackenrolle
Baumwolle yellow 66
Baumwolle green 19

- Game** Vorhang
Längsseite
Baumwolle green 19

Hängeregale
Regalhalter
Mal-/Magnettafel

Midi lit surélevé avec échelle en bois
Laminé hêtre

- Cosy** tête pelochon
Coton yellow 66
Coton green 19

- Game** rideau
pan latéral
Coton green 19

Etagère à suspendre
Support étagère
Tableau magnétique

Midi loft bed with wooden ladder
Laminated beech

- Cosy** neckroll
Cotton yellow 66
Cotton green 19

- Game** curtain
side part
Cotton green 19

Suspension shelf
Shelf-holder
Magnetic drawing board

Dimension/cm
90/200

48/15

197/111

70/14/5

80/48/2

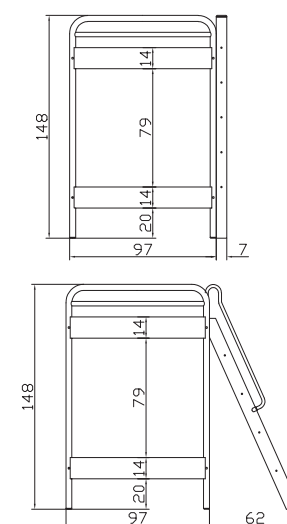



Maxi Etagenbett mit Treppe

Buche Nachbildung

Maxi Etagenbett mit Metallleiter

Noce

Cosy Nackenrolle

Window Vorhang

Stirnseite

Circus Vorhang

Längsseite

Baumwolle écru 63

Ossono Kommode

Box Bettkasten

Trio Kommode

Buche Nachbildung

Hängeregal

Weiss/alu

Box + Cover

Bettkasten + Deckel weiss

Vito Hocker orange 13

Ossono Kommode

Noce

7.24

Maxi lit superposé avec escalier

Laminé hêtre

Maxi lit superposé avec échelle en métal

Noce

Cosy tête pelochon

Window rideau

pan frontal

Circus rideau

pan latéral

Coton écru 63

Ossono commode

Box tiroir

Trio commode

Laminé hêtre

Étagère à suspendre

Blanc/alu

Box + Cover

tiroir + couvercle blanc

Vito tabouret orange 13

Ossono commode

Noce

Maxi bunk bed with stairs

Laminated beech

Maxi bunk bed with metal ladder

Noce

Cosy neckroll

Window curtain

front part

Circus curtain

side part

Cotton offwhite 63

Ossono chest of drawers

Box drawer

Trio chest of drawers

Laminated beech

Suspension shelf

White/alu

Box + Cover

drawer + cover white

Vito stool orange 13

Ossono chest of drawer

Noce

Dimension/cm

90/200

90/200

48/15

89/111

197/111

48/103/43

120/89/17

48/46/38

70/14/5

120/18/89

45/36/35

48/103/43

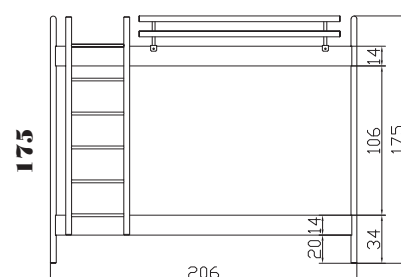
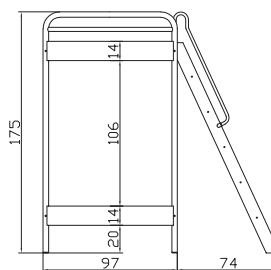

Maxi Eck-Etagenbett mit Holzleiter

Ahorn Nachbildung

Anbautisch Maxi 90

Ahorn Nachbildung

Regalhalter Maxi Regalbox L Mal/Magnettafel

Cosy Nackenrolle

Kunstleder black 312

Trio Kommode

Ahorn Nachbildung

Box Bettkasten

Ahorn Nachbildung

Maxi lit surposé en angle avec échelle en bois

Laminé érable

Table juxtaposée Maxi 90

Laminé érable

Support étagère Maxi Étagère L Tableau magnétique

Cosy tête pelochon

Cuir synth. black 312

Trio commode

Laminé érable

Box tiroir

Laminé érable

Maxi bunk bed across with wooden ladder

Laminated maple

Table unit Maxi 90

Laminated maple

Shelf-holder Maxi Shelf L Magnetic drawing board

Cosy neckroll

Synth. leather black 312

Trio chest of drawers

Laminated maple

Box drawer

Laminated mapled

Dimension/cm

90/200

90/65/73

48/15

48/46/38

120/89/17

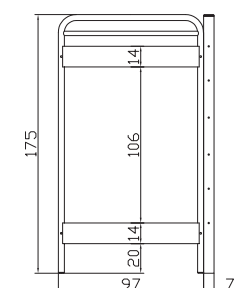
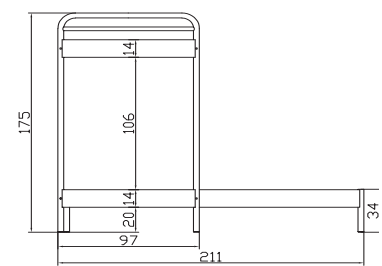

7.25



**Maxi
Maxi**

Anbautisch 90
Anbautisch 109
Regalboden 16
Regalboden 30
Kommode
Hocker

**Cassana
Vito**

Table juxtaposée 90
Table juxtaposée 109
Étagère 16
Étagère 30
Commode
Tabouret

Table unit 90
Table unit 109
Shelf 16
Shelf 30
Chest of drawers
Stool

Dimension/cm
90/65/70
109/65/70
83/16
83/30
77/103/43
45/36/35

**Maxi Hochbett mit
Holzleiter**
Eisenfarbig

Trio Nachttisch
Ahorn Nachbildung

**Maxi lit surélevé
avec échelle en bois**
Teinté fer

Trio table de nuit
Laminé érable

**Maxi loft bed
with wooden ladder**
Ironcoloured

Trio bedside table
Laminated maple

Dimension/cm
90/200

48/46/36



**XL
XL**

**Vito
Emino**

Anbautisch 90
Anbautisch 109
Regalboden 16
Regalboden 30
Hocker
Bank

Table juxtaposée 90
Table juxtaposée 109
Étagère 16
Étagère 30
Tabouret
Banquette

Table unit 90
Table unit 109
Shelf 16
Shelf 30
Stool
Bench

Dimension/cm
90/65/73
109/65/73
83/16
83/30
45/36/35
120/36/35

**XL Hochbett
mit Holzleiter**
Anthrazit

Trio Nachttisch
Eisenfarbig

**XL lit surélevé
avec échelle en bois**
Anthracite

Trio table de nuit
Teinté fer

**XL Loft bed
with wooden ladder**
Anthracite

Trio bedside table
Ironcoloured

Dimension/cm
120/200
140/200

48/46/38



XL Hochbett mit Treppe inkl. 2 x Handlauf und Absturzicherungen
Buche Nachbildung

XL lit surélevé avec escalier deux mains courantes incluses et barrières de sécurité
Laminé hêtre

XL bunk bed with stairs two handrails included and safetyrails
Laminated beech

Dimension/cm
120/200
140/200

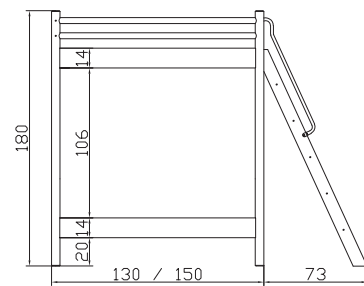

Lima Einzelbett siehe Seite 7.05
Farben siehe oben

Lima Lit single voir page 7.05
Couleurs voir ci-dessus

Lima single bed see page 7.05
Colours see above

90/200
120/200
140/200

Duostar X Lattenrost siehe Seite 7.09

Duostar X sommier voir page 7.09

Duostar X lathgrid see page 7.09

90/200
120/200
140/200

Cosy Nackenrolle Baumwolle écru 67

Cosy pelochon Coton écru 67

Cosy neckroll Cotton écru 67

48/15

Kleiderstange 120 + 140

Tringle 120 + 140

Clothes rail 120 + 140

120
140

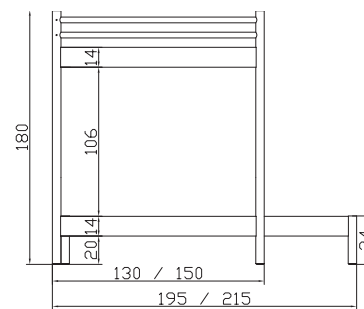

Anbautisch XL 90 Regalboden 16 Regalboden 30
Buche Nachbildung

Table juxtaposée XL 90 Etagère 16 Etagère 30
Laminé hêtre

Table unit XL 90 Shelf 16 Shelf 30
Laminated beech

90/65/73
83/16
83/30

Bücherstützen

Serre-livres

Bookend

Ossono Kommode
Trio Kommode
Buche Nachbildung

Ossono commode
Trio commode
Laminé hêtre

Ossono chest of drawers
Trio chest of drawers
Laminated beech

48/103/43
48/46/38

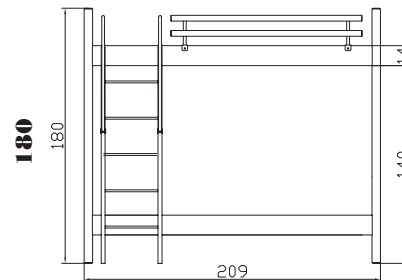

XXL Hochbett mit Treppe inkl. 2 x Handlauf und Absturzicherungen
Ahorn Nachbildung

XXL lit surélevé avec escalier deux mains courantes incluses et barrières de sécurité
Laminé érable

XXL loft bed with stairs two handrails included and safetyrails
Laminated maple

Dimension/cm
120/200
140/200

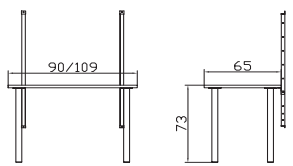

Duostar X Lattenrost siehe Seite 7.09

Duostar X sommier voir page 7.09

Duostar X lathgrid see page 7.09

120/200
140/200

Cosy Nackenrolle Baumwolle light blue 67

Cosy pelochon coton light blue 67

Cosy neckroll cotton light blue 67

48/15

Anbautisch XXL 109 Regalboden 16 Regalboden 30
Eisenfarbig

Table juxtaposée XXL 109 Etagère 16 Etagère 30
Teinté fer

Table unit XXL 109 Shelf 16 Shelf 30
Ironcoloured

109/65/73
83/16
83/30

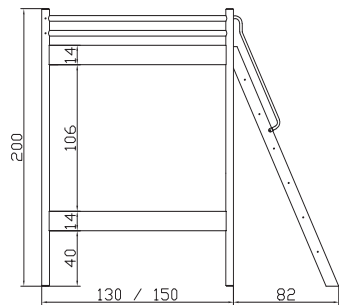

Cassana Kommode

Cassana commode

Cassana chest of drawers

77/103/43

Trio Kommode
Ahorn Nachbildung

Trio commode
Laminé érable

Trio chest of drawers
Laminated maple

48/46/38

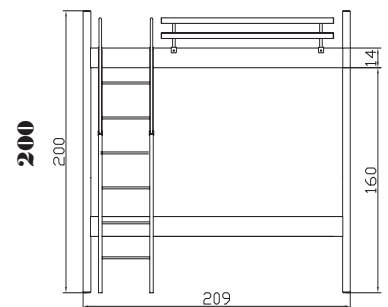



Pully Ausziehbett
unteres Bett zum
Herausziehen
Lattenrost integriert
Ahorn Nachbildung

Pully lit gigogne
Couchage inférieur
coulissant
Sommier intégré
Laminé érable

Pully pull-out bed
Bed underneath to
pull out
Integrated lathgrid
Laminated maple

Dimension/cm

**max. Matratzenhöhe
15 cm**
Breiten
Längen

**Hauteur max. du
matelas 15 cm**
Largeurs
Longueurs

**Height max. of
mattress 15 cm**
Widths
Lengths

90
200

Basic Matratze
Baumwolle red 18

Basic matelas
Coton red 18

Basic mattress
Cotton red 18

90/200

Trio Nachttisch
Ahorn Nachbildung

Trio table de nuit
Laminé érable

Trio bedside table
Laminated maple

48/46/38

Emilio-ala Herrendiener
Ahorn Nachbildung

Emilio-ala valet
Laminé érable

Emilio-ala dressboy
laminated maple

45/111/28

**Weitere Details
siehe Seite
8.26 - 8.27**

**Plus d'informations
voir page
8.26 - 8.27**

**Further details
see page
8.26 - 8.27**

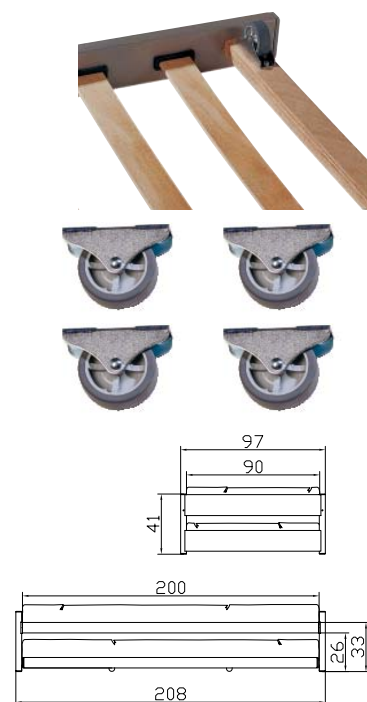

Clic Aufklappbett
unteres Bett zum
Aufklappen
Lattenrost integriert
Buche Nachbildung

Clic lit jumelés
Lit inférieur à ouv-
rir
Sommier intégré
Laminé hêtre

Clic bed to open
Bed underneath to
open
integrated lathgrid
Laminated beech

Dimension/cm

**max. Matratzenhöhe
15 cm**
Breiten
Längen

**Hauteur max. du
matelas 15 cm**
Largeurs
Longueurs

**Height max. of
mattress 15 cm**
Widths
Lengths

90
200

Basic Matratze
Baumwolle yellow 66

Basic matelas
Coton yellow 66

Basic mattress
Cotton yellow 66

90/200

Twin Nachttisch

Twin table de nuit

Twin bedside table

48/32/38

Ossono Kommode
Buche Nachbildung

Ossono commode
Laminé hêtre

Ossono chest of drawers
Laminated beech

48/103/38

**Weitere Details
siehe Seite
8.28 - 8.29**

**Plus d'informations
voir page
8.28 - 8.29**

**Further details
see page
8.28 - 8.29**

